



TRIPAR
INTERNATIONAL, INC.



2022
CATALOG



CREATING
BEAUTIFUL STORES,
Beautiful Homes



BEAUTIFUL HOME

Beautiful Store

Implement design principles and create stunning environments for your store and the home.



FOCAL POINT

Grab attention with prominent focal points.



Create beautiful environments.



LAYER PRODUCT

Layer product and build height that entertains the eye.





2

GROUP

Closely group product & furniture together to reinforce your theme.



For your store and home.



4

ORGANIZE

Organize to easily emphasize repetition and balance.

SOLUTIONS
To Inspire

We would love to see your visual stories and inspirations!

Tag @triparinternational on socials to get featured.

4 A



Beautiful faux suede fabric

4 B



4 D



4 C



**4 A
NECK & CHEST DISPLAY WITH
ADJUSTABLE HEIGHT POST**

(Available Mid-year)

Body form is 15.25" high, 10" wide at the shoulders, 10" circumference neck and 3" deep.

Min: 1

Code: E11800
22638



**4 B
DOG MANNEQUIN**

(Available Mid-year)

Mannequin is plastic covered with jersey fabric.

Overall length: 21"; 15.5" tall at head, 12" tall body, and 7.25" chest.

Min: 1

Code: E11500
22636



**4 C
FEMALE TABLETOP BODY FORM**

(Available Mid-year)

Fiberglass core covered with a faux suede material; is 28" high, 16.25" wide and 7.5" deep.

Min: 1

Code: E15500
22646



**4 D
FEMALE BODY FORM WITH BRUSHED SILVER
ADJUSTABLE HEIGHT POST**

(Available Mid-year)

Fiberglass body covered with faux 'suede like' soft material.

Body form height is 54" - 76". Mannequin is 28" tall, 16.25" wide, circumference: chest: 32", waist: 24", hips 33". Assembly Required

Min: 1

Code: E20000
22641





5 A

**5 A
POSEABLE FOAM HAND DISPLAY**

(Available Mid-year)

11" high, 4" wide with a 6" bendable round wrist; bendable fingers range from 2" to 3" long.

Min: 1 **Code: E03000**

22647



**5 B
HEAD AND SHOULDER BODY FORM**

(Available Mid-year)

Overall height is 18.5" high; 10" wide at the shoulders, 4" square at the base. Head is 8" deep front to back and circumference is 21".

Min: 1 **Code: E08500**

22642



**5 C
HEAD BODY FORM WITH WITH
ADJUSTABLE HEIGHT POST**

(Available Mid-year)

Head form is 10.5" high, 8" deep; 21" circumference. The diameter of the neck is 3.5" with a 12.25" circumference. Post extends from 8" to 13" high. Assembly Required

Min: 1 **Code: E08000**

22643



5 A



5 B



5 C



Beautiful faux suede fabric



The cream linen and jute body forms feature rigid fiberglass cores.



**6 A
FIBERGLASS FORMS**

Adjustable Floor Standing

56" - 64" Adjustable Height; Shoulder: 14.5", Bust: 35"; Waist: 26.5", Hips: 33.5"; Assembly Required

Jute/Burlap

Min: 1 Code: E08800  35432F

Cream Linen

Min: 1 Code: E08800  16408F

Table Top Forms

Shoulder: 14.5", Bust: 35"; Waist: 26.5", Hips: 33.5"; Overall: 30.5"h x 17"w x 9"d

Jute/Burlap

Min: 1 Code: E07900  35422F

Cream Linen

Min: 1 Code: E07900  16407F

**6 B
INFANT BODY FORM**

Infant body form size is similar to a 3 month old baby. It comes with both a silver cap and a removable head. Infant is 25.5" tall including head; 19" with steel cap. Base is 11.8" w x 11.8" d; Assembly Required

Min: 1 Code: E09700  21501

**6 C
TODDLER BODY FORM**

Toddler body form size is similar to a 1 year old toddler. It comes with both a silver cap and a removable head. Toddler is 27.6" tall including head; 22" tall with steel cap. Base is 12" diameter; Assembly Required

Min: 1 Code: E10700  21502



Mirror sold on page 34



7 A
ANTIQUED FEMALE FORM WITH 3 SHELVES

68"h x 18"w x 12"d; Overall height: 68"; 11.75" Clearance Between Shelves; Assembly Required;

Oversized; Additional Freight

Min: 1 Code: E32500  17825

7 B
ANTIQUED FLOOR BODY FORM- MALE

Adj. Height; Can Be Set Centered/ Off-Set; 54-72"h x 17.5"w x 13.5"d; Assembly Required

Min: 1 Code: E21500  17805

7 C
ANTIQUED FLOOR BODY FORM- FEMALE

Adj. Height; Can Be Set Centered/ Off-Set; 52-70"h x 13.75"w x 14"d; Assembly Required

Min: 1 Code: E21500  17811

7 D
ANTIQUED TABLE TOP HEAD FORM

28-31"h x 8"w, circumference 22"; Assembly Required

Min: 1 Code: E06800  17809

7 E
ANTIQUED TABLE TOP NECK FORM

Adj. Height; Finished Wood Top; 32-36.5"h x 12"w x 7"d; Assembly Required

Min: 1 Code: E09900  17821

Soft, durable linen. Adjustable base.

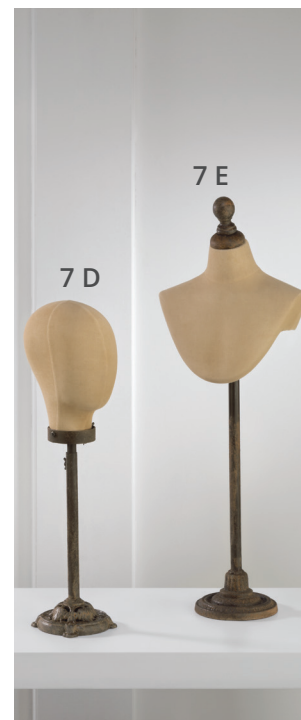



Mirror | MIRROR



8 A



8 B



8 C



8 D



8 E



8 F

8 A 
55" GOLD FRAMED FLOOR MIRROR
 Burnished gold metal rim.
 50"h x 19.25"d
Oversized; High UPS Surcharge - Truck Recommended
 Min: 1 Code: E17500
21576

8 B
NATURAL WOOD FLOOR MIRROR
 Features folding easel back for storage.
 56"h x 14"w Mirror
 60"h x 18"w x 1.75"d
Oversized; Additional Freight
 Min: 1 Code: E13000
19602

8 C 
EXTRA TALL 68" RECLAIMED WOOD MIRROR
 Overall size: 68" x 19"w; mirror dimensions: 59.25" x 9"w.
Oversized; High UPS Surcharge - Truck Recommended
 Min: 1 Code: E17500
21578

8 D 
55" FLOOR MIRROR WITH EASEL
 Burnished gold metal rim.
 Overall size: 55.25"h x 20"w x 17"d; mirror dimensions: 54"h x 18"
Oversized; High UPS Surcharge - Truck Recommended
 Min: 1 Code: E12500
21574

8 E
ROUND TABLE TOP MIRROR
 Does not adjust or swivel.
 Overall size: 16.5"h x 15.9"w x 4"d;
 mirror dimensions: 15.25" diameter.
 Min: 1 Code: E05000
19719

8 F
INDUSTRIAL TABLETOP ADJUSTABLE MIRROR STAND
 Perfect for your makeup, hair styling and shaving needs;
 Overall size: height range 19 to 25"; base is 5.75" d; mirror dimensions 7.75" diameter.
 Min: 1 Code: E03500
42855

Hang Your | HAT & JEWELS

FLOOR & TABLE TOP



HAT DISPLAYS



9 A
SET/2 BALLOON WIRE HAT STANDS - GOLD
 Perfect for all types of hats from caps, floppy brimmed, beanies, stocking, fedoras and more!

Small: 12.5"h x 6.5"w x 6.5"d
Large: 13.75"h x 6.5"w x 6.5"d

Min: 1 set



Code: **S05500**
21505

9 D
VERSATTACH ROUND HAT STAND - BLACK
 14"h x 4.5"w x 4.5"d

Min: 2



Code: **E01400**
21506

9 B
SET/2 BALLOON WIRE HAT STANDS WITH FLAT BASE - WHITE
(Available Mid-year)
 Perfect for all types of hats! Also great for displaying face masks.

Small: 12.5"h x 6.5"w x 6.5"d
Large: 13.75"h x 6.5"w x 6.5"d

Min: 1 set



Code: **S05500**
22590

9 E
BLACK WOODEN HAT STANDS
 Velvet Lined Top

Large: 14" x 4.75" dia Base

Min: 1



Code: **E01950**
41492

Small: 11" x 4.75" dia Base

Min: 1



Code: **E01750**
41491

9 C
14"H INDUSTRIAL DESIGN HAT STAND - METAL
 14"h x 4.75" dia

Min: 2



Code: **E01650**
42851

9 F
ADJUSTABLE HEIGHT HAT & WIG DISPLAY - SILVER
(Available Mid-year)

This display adjusts from 13" to 24.5" tall with a 5.5" in diameter.

13.5" x 6.25" w x 6.25" d

Assembly Required

Min: 1



Code: **E03500**
22658



10 A

**10 A
PARISIAN WREATH HANGERS**

17.5" - 26" x 6"w x 5.25"d; Adjustable Hook Height

Two-Tone Brown

Min: 2 Code: E01700  59426

Gold Parisian Wreath Hanger

Min: 2 Code: E01700  59416

10 B

**10 B
ADJUSTABLE METAL HANGERS WITH HOOK**

Hang a purse, wreath, scarf or more; 17.5-24"h x 6.75"w x 6.75"d

Cream Metal Hanger w/ Hook

Min: 1 Code: E02000  17848 17848

Oil Rubbed Bronze Metal Hanger

Min: 1 Code: E02000  17849 17849



10 C



**10 C
BROWN TWISTED MOTIF ADJUSTABLE WREATH HANGER**

14.5" - 27" ; Adjustable Hook Height x 8"dia

Min: 2 Code: E01475  58942 58942

10 D

**10 D
OVER-THE-DOOR HOOK - GOLD**

Wreath Hook- Basic Gold ; 18"h x 2.625"w x 3.75"d door hook

Brown

Min: 6 Code: E00330  33308 33308

Gold

Min: 6 Code: E00330  33300 33300



Adjustable | HANGERS

SHOWCASE DRESSES, SCARVES, PURSES, WREATHS & MORE



WREATH, ACCESSORY HANGERS

11 A



11 B



11 B



11 C



11 A
ADJUSTABLE DOUBLE SIDED METAL
WREATH HANGER - EXTRA TALL

(Available Mid-year)

Great for wreaths, purses, scarves and more.
Adjusts from 35.5" to 60" tall 36"h x 7"w x 7"d

White

Min: 2
0 25403 22615 4

Code: E03300
22615

Black

Min: 2
0 25403 22616 1

Code: E03300
22616

11 B
ADJUSTABLE SCARF & TIE STAND

(Available Mid-year)

Metal expandable display stand is perfect for
scarves, ties, hand towels. Height range from
15" to 24.5" high.

Gold

Min: 1
0 25403 22663 5

Code: E02800
22663

Silver

Min: 1
0 25403 22660 4

Code: E02800
22660

11 C
SINGLE HOOK ADJUSTABLE HEIGHT
TABLETOP DISPLAY

(Available Mid-year)

Height range from 15" - 27" tall with a 2.25" long
hook and 5" x 5" base.
15.25"h x 5"w x 5"d
Assembly Required

Min: 1

0 25403 22652 9

Code: E02400
22652

\$100
minimum order



12 A

12 A
SET/2 JEWELRY T-BARS SINGLE & DOUBLE

Perfect sized set. Fits long, medium, short necklaces and bracelets on both of these t-bars.

1-Tier: 23.25" h x 14" w x 5.25" d, 20.75" h

2-Tier: 17.75" h x 14" w x 5.25" d, 6.75" h, 8" h

Min: 1 set Code: S04500



20514

12 B
SINGLE GLASS "T" BAR

10.5" h x 9.2" w x 3" d

Min: 1 Code: E02600



19752

DOUBLE GLASS "T" BAR

14.8" h x 9.3" w x 5.4" d; Top: 13.5" h; Bottom: 9" h; Assembly Required

Min: 1 Code: E04400



19753



12 B



12 C

12 C
RECTANGLE JEWELRY DISPLAY

Hangs necklaces up to 16" long; 18" h x 7.75" w x 4" d

Large - 18" tall

Min: 2 Code: E01350



20533

Hangs necklaces up to 10" long; 12" h x 7.5" w x 3" d

Small - 12" tall

Min: 2 Code: E01025



20532

12 D
WOODEN TRIANGLE JEWELRY DISPLAY SET

Unique jewelry display; Nests for storage.

Small: 6" h x 6" w x 6" d

Large: 8" h x 7.7" w x 7.7" d

Min: 1 set Code: S02300



20502



12 D

Elegant & VERSATILE

CLASSIC STANDS FOR JEWELRY AND MORE



13 A



Adjustable from 13.25" to 24.5"

13 B



Heavy base for secure displays

13 A ADJUSTABLE T-BAR STANDS

(Available Mid-year)

T-Bar Display is 11" wide and height range from 13.5" to 24" high.
13.75"h x 11"w x 6"d. Assembly Required

Min: xx

Silver

Min: 1 Code: E03000  22654

Gold

Min: 1 Code: E03000  22662

13 B SUPER TALL T-BAR STANDS

Stand is perfect for necklaces, scarves, wristlets and more.
Assembly Required.

Super Tall: 34.25"h x 17"w x 7"d

Black

Min: 1 Code: E03000  21628

White

(Available Mid-year)

Min: 1 Code: E03000  22507

Tall: 22.25"h x 13"w x 6.5"d

Black

Min: 1 Code: E02000  21627

White

(Available Mid-year)

Min: 1 Code: E02000  22506

13 C INDUSTRIAL T-BAR STANDS

Large: 19.25"h x 11"w x 4.75"d

Min: 1 Code: E01600  17912

Small: 11.5"h x 11"w x 4.75"d

Min: 1 Code: E01425  17910





13 C





14 A
SMALL GREY WOODEN WALL JEWELRY STORAGE CABINET
 Display or store jewelry and scarves. Perfect for small spaces.
 31" h x 22" w x 3.25" d
 Min: 1 Code: E11500  20541

14 C
SMALL BLACK WOODEN WALL JEWELRY STORAGE CABINET
 Display or store jewelry and scarves. Perfect for small spaces.
 31" h x 22" w x 3.25" d
 Min: 1 Code: E11500  20537

14 B
LARGE GREY WOODEN WALL JEWELRY STORAGE CABINET
 43.25" h x 23.5" w x 3.5" d
 Min: 1 Code: E16000  15468

14 D
LARGE BLACK WOODEN WALL JEWELRY STORAGE CABINET
 43.25" h x 23.5" w x 3.5" d
 Min: 1 Code: E16000  20538

CREATE YOUR
Focal point

BEAUTIFUL FOILED
BRANCH ART PERFECT
FOR JEWELRY DISPLAY

15 A
METAL BRANCH WALL DECOR

Beautiful decor which can also be used for
displaying/hanging jewelry.
38.6"h x 26"w x 3.95"d

Gold
Min: 1 Code: E11000 20515



15 B
GOLD FOIL METAL JEWELRY TREE

Use in closets, bedroom and bathroom for
beautiful storage!

Approx. 30 branches; 14.875"h x 9.75"w x 8.5"d
Min: 1 Code: E02900 19751



\$100
minimum order



Accessory | PRESENTATION

PEGGING PRODUCT WITH EASE



16 A



16 D



16 B

16 C

DYNAMIC *Displays*

16 A 2-SIDED WOODEN SPINNER DISPLAY

This wooden spinner will help create a beautifully elegant display for jewelry, keys and more. Rotates for easy viewing; 12 Hooks Each Side 24"h x 15.25"w x 9.5"d

Natural

Min: 1 Code: E10000  17829

White

Min: 1 Code: E10000  21661

16 B SQUARE WOOD JEWELRY SPINNER W/HOOKS

4 sided spinner; Includes 40, 2.75" white hooks; 20.3"h x 8.65"w x 8.65"d

Min: 1 Code: E09250  20525

16 C METAL HOOKS SET OF 20 FOR ITEM #20525

Use these additional hooks too add more hanging positions to 42B; 0.65"h x 0.65"w x 2.75"d

Min: 1 Code: P02196  21670

16 D BROWN METAL SPINNING CARD HOLDER/DISPLAY

4 panels with approx 13 loops each; 25"h x 8"w x 8"d

Min: 1 Code: E04500  19686



17 A

17 A
CREAM LINEN NECK FORM

Uniquely showcase and organize your jewelry and accessories.

Medium: 10" h x 8" w x 4.75" d

Min: 2

Code: E01500



35721

Large: 12" h x 8.25" w x 5.5" d

Min: 2

Code: E01775



35722

17 B
NATURAL JUTE NECK FORM

Uniquely showcase and organize your jewelry and accessories. Their super chic look will enhance any piece.

Medium: 11" h x 8" w x 4.75" d

Min: 1

Code: E01300



15405

Large: 16" h x 10" w x 5.5" d

Min: 1

Code: E03000



15406



17 B



17 C

17 C
GRAY LINEN NECK FORM

Dark gray fabric creates a super chic look.

Medium: 10" h x 8" w x 4.75" d

Min: 2

Code: E01500



21511

Large: 12" h x 8.25" w x 5.5" d

Min: 2

Code: E01775



21512

17 D
NATURAL JUTE T- BAR STANDS
Bracelet-Watch Stand - 5" h x 7.75" w x 3" d; 1.5" dia bar

Min: 2

Code: E00900



15401

Necklace Stand - 12.75" h x 12.25" w x 3.25" d; 2" dia. bar

Min: 1

Code: E01475



15402



17 D



17 E

17 E
GRAY LINEN T-BAR STANDS
Bracelet-Watch Stand - 5.65" h x 8" w x 2.9" d; 1.5" dia bar

Min: 2

Code: E00900



21513

Necklace Stand - 12.5" h x 12.15" w x 3.25" d; 2" dia bar

Min: 2

Code: E01475



21514



WOOD NECK FORM STANDS

SMALL WOOD
NECK FORM
10"H × 7.25"W × 3"D
MIN: 2
Code: E01550

MEDIUM WOOD
NECK FORM
13.75"H × 8.75"W × 3.5"D
MIN: 2
Code: E01950

LARGE WOOD
NECK FORM
18"H × 9.5"W × 3.5" D
MIN: 2
Code: E02400

18 A WHITE FINISH

20521

20522

20523

18 B BLACK FINISH
(Available Mid-year)

22630

22631

22632

17810

17814

17818



18 D JEWELRY DISPLAY HAND

Display necklaces, bracelets, rings, key rings. Made of resin.
11.75"h × 3.5"w × 4" D

Min: 1 Code: E02000 20507



\$100
minimum order

Colors & TEXTURES

PERFECT FOR HOME CLOSETS



19 A
WHITE WOOD NECK FORM

- Small**- 8.5"h x 5.15"w x 4"d
Min: 2 Code: **E00725**  21561
- Medium** - 11.25"h x 6.5"w x 5.5"d
Min: 2 Code: **E00950**  21562
- Large**- 15"h x 9"w x 6.5"d
Min: 2 Code: **E01250**  21563

19 B
WOOD PEG JEWELRY DISPLAY - WHITE

Features 9 - 3/4" long pegs, 3/8" dia. for hanging jewelry. Easel back base detaches for flat storage; Assembly Required

- Small**: 10"h x 7"w x 3.75"d
Min: 1 Code: **E01350**  20587
- Medium**: 14"h x 8.5"w x 5.5"d
Min: 1 Code: **E01550**  20588
- Large**: 18"h x 9"w x 6.5"d
Min: 1 Code: **E01850**  20589



19 B

19 C
WOOD PEG JEWELRY DISPLAY - BLACK

Features 9 - 3/4" long pegs, 3/8" dia. for hanging jewelry. Easel back base detaches for flat storage.; Assembly Required.

- Small**: 10"h x 7"w x 3.75"d
Min: 1 Code: **E01350**  21631
- Medium**: 14"h x 8.5"w x 5.5"d
Min: 1 Code: **E01550**  21632
- Large**: 18"h x 9"w x 6.5"d
Min: 1 Code: **E01850**  21633



19 C



Store & Home | ORGANIZATION

SIMPLE & FUNCTIONAL



20 A 3-TIER OVAL TABLETOP DISPLAY

Create height with this stand which features raised edges. 24.2”h x 21.7”w x 13.75”d; Assembly Required
Min: 1

Code: E11500
21571



20 B 26” ROUND WALL MIRROR

Clean simple design features a gold rim. 1.7”h x 26”w x 26”d
Min: 1

Code: E07000
21575



20 C 55” FLOOR MIRROR WITH EASEL BACK

Features an easel back or can be leaned against a wall. 55.25”h x 20”w x 17”d
Min: 1

Code: E12500
21574



20 D METAL CONVERTIBLE SIDE TABLES/BINS SET

Tabletops can be used as a flat surface or a bin. 23.5”h x 15.75”w x 15.75”d
Min: 1 set

Code: S14500
21572





21 E

21 E
WINE BOTTLE HOLDER - TABLETOP

Holds 5 bottles of wine.
10.7" h x 10.7" w x 6.4" d
Min: 1

Code: **E02150**
21573



21 F

21 F
METAL SIDE TABLES - SET/3

Burnished finish for an aged appearance.

Large: 29.75" h x 13.75" w x 10" d
Medium: 25.75" h x 11.75" w x 10" d
Small: 21.75" h x 9.75" w x 10" d

Min: 1 set

Code: **S13500**



19631



21 G

21 G
6-TIER METAL OVAL DISPLAY TOWER

Antiqued, distressed finish.

67" h x 30.25" w x 21.75" d

Min: 1

Code: **E31000**

19611



21 H

21 H
INDUSTRIAL METAL CONSOLE TABLE

Antiqued bronze finish for an aged appearance.

29.75" h x 50.5" w x 14" d; Assembly Required;
Oversized; Additional Freight

Min: 1

Code: **E17500**

19632



21 I

21 I
METAL DESK WITH SHELVES AND 2 DRAWERS

Burnished finish for an aged appearance.

30" h x 47.25" w x 14" d

Assembly Required;

Oversized; Additional Freight

Min: 1

Code: **E29000**

19633





22 A



22 B



22 C

4-TIER WOODEN A-FRAME DISPLAY

Easy assembly; 55.4”h × 55.15”w × 12.7”d;

Assembly Required;

Oversized; Additional Freight

Min: 1

22 A

White

Code: E19800



21665

22 B

Wooden

Code: E19800



17806

22 C

3-TIER A-FRAME DISPLAY SHELF

Antiqued, Industrial Metal Finish;

54.5”h × 63”w × 16.4”d Assembly Required;

Oversized; Additional Freight

Min: 1

Code: E26000



19612

\$100
minimum order



23 A

Beautiful glass & wood table; stack multiples together to fit any space.



23 A
3-TIER GLASS & WOOD FRAME
DISPLAY SHELF

Clean simple white design w/ tempered glass shelves. Frame is fir wood; 14" between shelves; 31"h x 52"w x 18"d; Assembly Required; Ships in 2 Cartons; *Oversized; Additional Freight*

Min: 1 Code: E42500
20520



23 B
EMPRESS CONSOLE TABLE

Natural wood table with black hairpin-style legs; 30"h x 46"w x 16"d; Assembly Required; *Oversized; Additional Freight*

Min: 1 Code: E15000
18565



23 B



23 C
FARMHOUSE CONSOLE TABLE

Natural wood top and weathered cream base; 30"h x 48"w x 18"d; Assembly Required; *Oversized; Additional Freight*

Min: 1 Code: E26000
18675



23 D
FARMHOUSE STYLE BENCH

Natural wood top and weathered cream base; 19"h x 51"w x 15"d; Assembly Required; *Oversized; Additional Freight*

Min: 1 Code: E21500
18674



23 C



23 D



Tiered | TABLES

STAGING BEAUTY



24 A

24 A MODERN BLACK METAL TABLES

Sleek modern black table; Assembly Required

Large

31.45"h x 46.15"w x 20"d

Min: 1

Code: E23000



21636

Small

26.85"h x 39.25"w x 20"d

Min: 1

Code: E22000



21635

24 B MODERN WHITE WOOD TABLES

White, modern chunky display table; Assembly Required

Large *Oversized; Additional Freight*

32"h x 47.25"w x 19.7"d

Min: 1

Code: E23500



20565

Small

27.25"h x 39.25"w x 18.65"d

Min: 1

Code: E21000



20566



24 B



24 C

24 C RUSTIC WOOD TABLES

This bar height tall table is perfect as a display on its' own, used with bar stools or nested with Console Table; Assembly Required

Tall Table

39.25"h x 56.9"w x 21"d

Min: 1

Code: E27500



21662

Console Table

31.15"h x 48"w x 16"d

Min: 1

Code: E22000



21660

24 D METAL AND GLASS SLIM TABLES - GOLD

Tempered glass top and gold colored base;

Assembly Required; *High UPS Surcharge - Truck Recommended*

Large

39.5"h x 46"w x 17.75"d

Min: 1

Code: E29000



20549

Medium

31"h x 39.5"w x 15.7"d

Min: 1

Code: E24000



20548

Small *Oversized; Additional Freight*

20"h x 31.75"w x 15.75"d;

Min: 1

Code: E16000



20547



24 D



25 A
WOOD NESTING TABLES WITH CASTERS - SET/3
Metal legs and lockable casters. Tables nest for storage and displays.

Large: 30.25"h x 47.5"w x 15.5"d
Medium: 27.25"h x 41"w x 14.5"d
Small: 24"h x 34.75"w x 13.75"d
Oversized; Additional Freight

White Wood Nesting Tables w/ casters
Min: 1 set **Code: S30000**  **20500**

Brown Wood Nesting Tables w/ casters
Min: 1 set **Code: S30000**  **17879**

25 B
2-TIER WOODEN PLANK TABLE 
Black Metal A-Frame Legs; 21" clearance between shelves; 30"h x 60.75"w x 18.5"d; oversized; assembly required;
High UPS Surcharge - Truck Recommended
Min: 1 **Code: E24000**  **17980**

25 C
3-TIER WOOD & METAL SHELF UNIT
Raw wood planks; square metal legs; oversized; additional freight 47.25"h x 47.25"w x 17"d; assembly required;
Oversized; Additional Freight
Min: 1 **Code: E25000**  **17989**



Side | TABLES

MODERN, CLEAN LINES



26 A

26 A ROUND GOLD ACCENT TABLES - SET/2

Add a touch of glam with these contemporary gold accent tables. Great for displays or as end tables.

Large: 24"h x 18.1"w x 18.1"d

Small: 20"h x 16" w x 16"d

Min: 1 set Code: **S18500** 20564



26 B 3-TIER METAL MIRROR STAND

Modern three-tier stand features black iron legs, gold rims and mirrored tabletops. 40.3"h x 17.25"w x 17.25"d; ships flat; Simple Assembly

Min: 1 Code: **E11500** 21526



26 C MIRROR SIDE TABLES - SET/2

Set of 2 tables feature iron legs, gold metal rims and a mirrored top.

Ships flat; Simple Assembly

Large: 23.75"h x 17.25"w x 17.25"d

Small: 20"h x 15" w x 15"d

Min: 1 set Code: **S11000** 21527



26 B

26 C

26 D RITZ ROLLING BAR CART

Brushed gold finish frame with two matte black wood shelves, locking casters, racks hang 25 stemware glasses; 20.5"h shelf space; 37.25"h x 35"w x 18.25"d

Oversized; Additional Freight

Min: 1 Code: **E19500** 18510



26 D



27 A
METAL SIDE TABLES - SET/3

Three nesting tables offer great surface space and versatility. They can be used individually or stacked together to provide cascading levels.

Large: 26" h x 27.5" dia.
Medium: 23" h x 24" dia.
Small: 20" h x 20" dia.
Assembly Required
Min: 1 set

White

Code: S20000
22531

Gold Edge Black

Code: S20000
19691



SURFACES

with

Style

27 B
4-TIER METAL OBELISK

Create a beautiful vignette of photos, artwork and more with this Stackable 4-Tier Metal Obelisk. Display the shelving stacked together or as individual risers and stands throughout your store. 65.5" h x 16.25" w x 16.25" d

Distressed Cream

Min: 1

Code: E15000
59361

Gunmetal

Min: 1

Code: E15000
59363



\$100
minimum order



Store & Home | ORGANIZATION

SIMPLE & FUNCTIONAL



28 A

28 A 4-TIER DISPLAY WITH GLASS SHELVES AND 2 DRAWERS

Bottom and top shelves have no compartments. Middle two shelves have glass covered drawers with compartments.

61.5" h x 32.75" w x 15.8" d

Assembly Required

Upsize; Additional Freight

Min: 1

Code: E42500

19707



28 B

28 B SIDE TABLES WITH GLASS SHELF AND DRAWER - SET/2

Each side table has a glass top. Storage drawers with compartments are visible underneath.

Large: 32" h x 16.75" sq

Small: 27.75" x 14" sq

Min: 1 set

Code: S22500

19708



28 C CONSOLE TABLE WITH GLASS TOP AND DRAWER

One long drawer under a glass top is divided into compartments for storage.

32.5" h x 48" w x 17.5" d; Assembly required

Min: 1

Code: E29900

20578



28 C





Stack 7 feet tall!



29 A

**29 A
WHITE WOOD RISERS - SET/6**

Tops feature slight recess for secure stacking. 84" h Overall; 9" sq, 11" sq, 13" sq, 15" sq, 17" sq, 19" sq
Min: 1 set

Code: S37500
20501



29 B

**29 B
DISTRESSED WOOD RISERS - SET/6**

Tops feature slight recess for secure stacking. 84" h Overall; 9" sq, 11" sq, 13" sq, 15" sq, 17" sq, 19" sq
Min: 1 set

Code: S37500
16440



29 C

**29 C
BLACK WOOD RISERS - SET/6**

Tops feature slight recess for secure stacking. 84" h Overall; 9" sq, 11" sq, 13" sq, 15" sq, 17" sq, 19" sq
Min: 1 set

Code: S37500
19650





Rise | TO NEW HEIGHTS

CLASSIC TABLE TOP RISERS

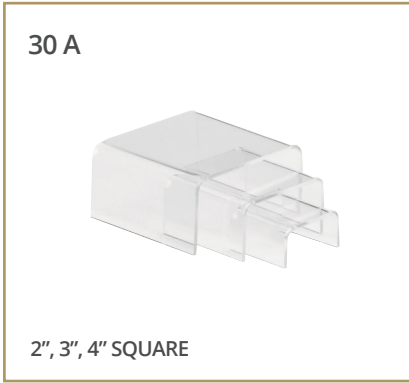

CLEAR ACRYLIC LOW PROFILE RISERS

Sold in sets of three.

Basic Packaging with UPC tag only.

30 A

1"h x 2"sq;
1.5"h x 3"sq;
2"h x 4"sq; 1/8" thick

Min: 1 set

Code: S00625



48-2151

30 B

1.25"h x 3.5"sq;
1.75"h x 4.75"sq;
2.5"h x 6"sq" d; 1/8" thick

Min: 1 set

Code: S01000



48-2152

30 C

4"h x 8"sq;
5"h x 10"sq;
6"h x 12"sq; 1/4" thick

Min: 1 set

Code: S05500



23-2163

CLEAR ACRYLIC SQUARE RISERS

Sold in sets of three.

Basic Packaging with UPC tag only.

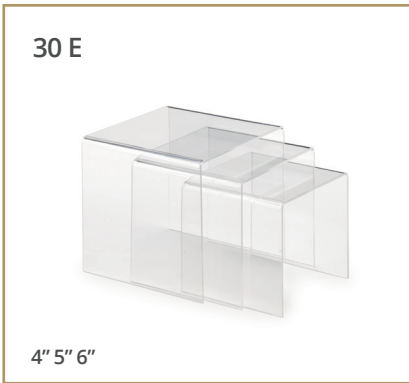
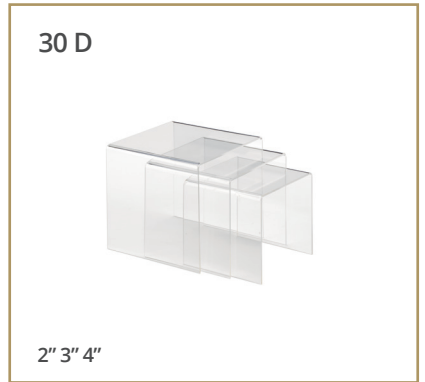
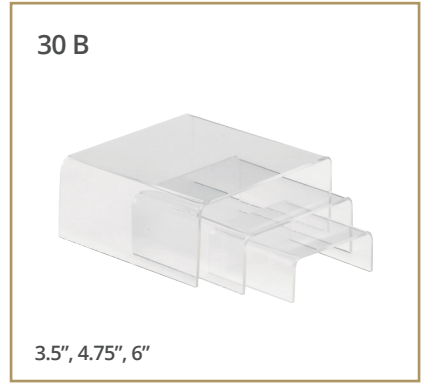
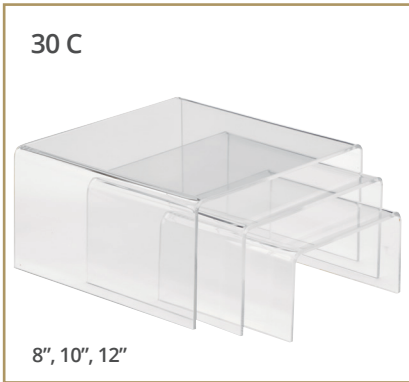

30 D

2", 3", 4" square riser set, 1/8" thick

Min: 1 set

Code: S00850



23-2133

30 E

4", 5", 6" square riser set, 1/8" thick

Min: 1 set

Code: S01550



23-2137

30 F

7", 8", 9" square riser set, 1/4" thick

Min: 1 set

Code: S04500



23-2143

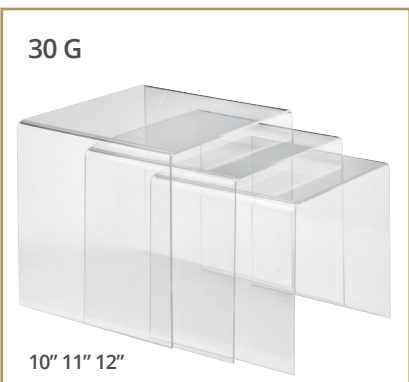

30 G

10", 11", 12" square riser set, 1/4" thick

Min: 1 set

Code: S07650



23-2147

30 H

CLEAR ACRYLIC SQUARE RISER - SINGLE

4" square sold (single), 1/8" thick

Min: 2

Code: E00575



23-2135

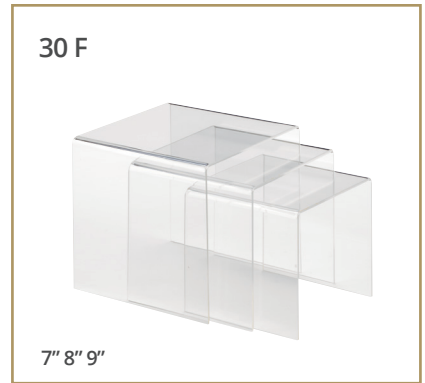



31 A

SQUARE GLASS MIRROR RISERS - SET OF 3

Small: 4" sq

Medium: 6" sq

Large: 8" sq

31 A

Smoke

Smoke color is a gray, blue color.

Min: 1 set

Code: S07600

20615



31 B

Clear glass

Min: 1 set

Code: S07600

20610



31 B



31 C

31 C

GLASS MIRROR PEDESTAL RISERS SET OF 4

Extra Small: 4" sq

Small: 6" sq

Medium: 8" sq

Large: 10" sq

Min: 1 set

Code: S11500

36575



31 D

BLACK ACRYLIC RISERS - SET OF 3

31 D

Small: 4" sq

Medium: 5" sq

Large: 6" sq

Min: 1 set

Code: S01600

21522



31 E

Small: 2" sq

Medium: 3" sq

Large: 4" sq

Min: 1 set

Code: S00900

21521



31 E



31 F

31 F

4" SQUARE (SINGLE)

Black, 1/8" thick

Min: 2 set

Code: E00600

21520





Storage | SOLUTIONS

MODERN & CONTEMPORARY



32 A

32 A
3-TIER WOODEN TABLETOP DISPLAY
22"h x 18"dia, 12.5"dia, 8"dia, 1" Lip;
Assembly Required

White:

Min: 1

Code: E08500

16426



32 A

Natural:

Min: 1

Code: E08500

21663



32 A

Black:

Min: 1

Code: E08500

20509



Tiers add depth & interest for store & home



32 B

32 B
METAL CONVERTIBLE SIDE TABLES/BINS SET - BLACK

(Available Mid-year)

Tabletops can be turned over and used as bins.

Small table: 20"h x 13.75" sq. x 4.75"d

Large table: 23.5"h x 15.75" sq. x 4.67" d

Min: 1 set

Code: S14500

22551



32 C

32 C
METAL CONVERTIBLE SIDE TABLES/BINS SET - BRONZE

Tabletops can be turned over and used as bins.

Small table: 20"h x 13.75" sq. x 4.75"d

Large table: 23.5"h x 15.75" sq. x 4.67" d

Min: 1 set

Code: S14500

21572



32 D

32 D
3 TIER OVAL TABLETOP DISPLAY

Create height with this stand which features raised edges. Assembly Required.

Overall size: 24.2"h x 21.7" w x 13.75" d

Min: 1

Code: E11500

21571







33 A
SQUARE 6 TIER METAL DISPLAY - WHITE
 12.25" display space between each shelf; each shelf has a 2" high edge;
 67.75"h x 26"w x 26"d; Assembly Required;
Oversized; Additional Freight
 Min: 1 Code: E35000  21621

33 B
6-TIER METAL OVAL DISPLAY TOWER
 Antiqued, distressed finish 67"h x 30.25"w x 21.75"d
 Assembly Required
 Min: 1 Code: E31000  19611



34 A
6 METAL BIN TABLETOP DISPLAY
 Black 22.75”h x 10.9”w x 9.25”d; Removable bins: 7”l x 4.5” w 3.5”d
 Min: 1 set Code: E11000  21556 1 **21556**



34 A
6 METAL BIN TABLETOP DISPLAY
(Available Mid-year)
 White 22.75”h x 10.9”w x 9.25”d; Removable bins: 7”l x 4.5” w 3.5”d
 Min: 1 set Code: E11000  22611 6 **22611**



34 B
4-BIN MESH DRAWER DISPLAY
 Black and brown metal mesh drawers pivot to open. Solid top;
 Overall: 31.5”h x 15”w x 18”d; Bins: 5.75”h x 13.5”dia
 Min: 1 Code: E13500  18589 5 **18589**



34 C
6-BIN MESH ROTATING DISPLAY
 Black and brown metal mesh. Three tiers with 2 bins each rotate on central post for versatile displays;
 Overall: 29.25”h x 16.75”w x 8”d Bins: 5.25”h x 7.75” dia
 Min: 1 Code: E07200  18590 1 **18590**



34 D
FOOD SAFE GLASS GLOBE W/ BURNT WOOD BASE
 Large Globe: 14”dia w/ 6” opening; Concave Base: 11.5”dia x 2”h
 Min: 1 Code: E06800  18627 4 **18627**



34 E
SET/2 WHITE WOODEN SQUARE RISERS/BINS
 Set of nesting tabletop risers, can also be used as bins.
 Large: 6.5”h x 13”sq x 2.25”d
 Small: 4”h x 12”sq x 1”d
 Min: 1 set Code: S05500  20531 0 **20531**



TEXTURED METAL BINS - SET/3

Large: 21.25" h x 11.75" dia. x 11" d

Medium: 18.75" h x 10" dia. x 9" d

Small: 14.25" x 7" dia. x 9" d

Assembly Required

Min: 1 set

Code: S11500

35 A

Gold



19692

35 B

White



22532

(Available Mid-year)

35 C

Black



21610

UNIQUE
Solutions

GREAT FOR CONSOLIDATING
PRODUCTS AT A STORE OR
FOR HOME ORGANIZATION



35 D

BAMBOO BINS - SET/3

Large: 28" h x 14.75" dia. x 11.75" d

Medium: 24.75" h x 12.75" dia. x 10" d

Small: 21.75" x 10.75" dia. x 9" d

Min: 1 set

Code: S10000



19715

35 E

METAL BINS WITH GOLD STANDS - SET/2

Large: 18.5" h x 12.75" w x 9" d

Small: 15" h x 11" w x 7.5" d

Min: 1 set

Code: S09500



21530



35 B



35 C



35 D



35 E

\$100
minimum order



Displays & STORAGE

FUNCTIONAL, TIERED & UNIQUE



Rack and baskets sold separately

Best Sellers

**DISPLAYS
TO ADJUST
TO YOUR NEEDS**

Baskets:

Perfect on tabletops or hung on walls - a visually stunning, versatile display for your store or home organization



36 A

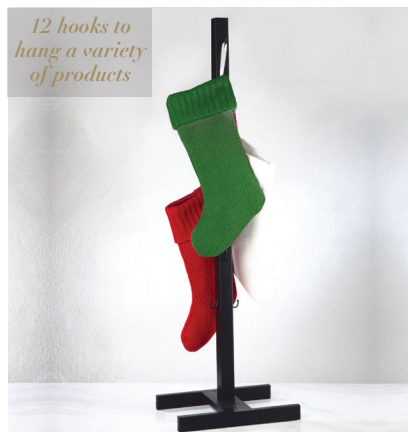

12 hooks to hang a variety of products



36 B



36 B

**36 A
BLACK METAL POST ONLY**

This post is designed to hang Gold Bins #21642 and Black Bins #21643.
44.25" h x 14" w x 9.65" d; Assembly Required
Min: 1 Code: E05700



21634

**36 B
METAL BINS SET OF 12 (BINS ONLY)**

Set of 12 bins are perfect for tabletop use, hung on a wall or put on Metal Post #21634 to create a display of multiple bins.
6.25" h x 8.75" dia.

Gold

Min: 1 set Code: S08900
21642



Black

Min: 1 set Code: S08900
21643





37 A



37 A



37 B



37 B



**37 A
3-TIER CRATE STAND**

Overall: 35.5" h x 15.75" w x 12.75" d
Crate: 7" h x 14.375" w x 7.5" d;
Not food safe.

Natural Wooden

Min: 1

Code: **E15500**
18671



Black
(Available Mid-year)

Min: 1

Code: **E15500**
22556



**37 B
METAL CONVERTIBLE SIDE
TABLES/BINS SET**

Tabletops can be turned over
and used as bins.
Small table: 20" h x 13.75" sq. x
4.75" d
Large table: 23.5" h x 15.75" sq. x
4.67" d

Gold

Min: 1 set

Code: **S14500**
21572



Black

(Available Mid-year)

Min: 1 set

Code: **S14500**
22551



**37 C
SET/2 BOAT DISPLAY WITH
SHELVES**

Stained wood hull and metal
frame with removable shelving.
Features an anchor hook at the
top.

Large: 50.6" h x 16" w x 9.25" d;
Approx. 12-15" between shelves

Small: 39.75" h x 13.25" w x 8.5" d
Approx. 15" between shelves

Min: 1 set

Code: **S25500**
18550





38 A



38 A

2-SIDED SHUTTER LADDER DISPLAY

Locking clasp; Accessorize with metal 3.5" hooks and metal baskets (not included).

64"h x 16"w x 39.50"d; Hooks and baskets sold separately;

Oversized; Additional Freight

Distressed white

Min: 1 Code: E22500  20540

Rustic Black

Min: 1 Code: E22500  17903

38 B

PACK/12 BLACK METAL 3.5" HOOKS

Use with Shutter Ladder.

Min: 1 Pack Code: P01225  16489

38 C

METAL BASKET FOR SHUTTER LADDER

Add additional storage and display options to the Shutter Ladder Display with this Basket. 8"h x 12"w x 8.5"d

Min: 2 Code: E01450  16509

38 D 

INDUSTRIAL METAL BIN ORGANIZER/DISPLAY

7 Compartments. Each tray fits all three levels and can be moved to create a different look.

38"h x 27"w x 11.25"d; *High UPS Surcharge - Truck Recommended*

Min: 1 Code: E27500  19671

Baskets & hooks sold separately

38 A



38 D





39 A 
INDUSTRIAL BLACK IRON 12-BIN SHELF ON CASTERS

Locking Casters; Wire Mesh Shelves; Removable Bins: 7" h x 8" w x 14" d;
Overall: 36" h x 33.25" w x 14" d; *Oversized;*
High UPS Surcharge - Truck Recommended

Min: 1

Code: E50000



17871



39 B



39 B 
INDUSTRIAL WOODEN BIN ORGANIZER/ DISPLAY

7 Compartments - Each tray fits all three levels and can be moved to create different storage configurations.

38" h x 27" w x 11.25" d; *High UPS Surcharge - Truck Recommended*

Min: 1

Code: E29000



21550

39 C 
2-TIER IRON DISPLAY W/ REMOVABLE BASKETS

Incl. 6 Extra Deep Metal Display Baskets; Metal Baskets: 9.5" h x 11.5" dia; 38.75" h x 37.5" w x 12.5" d; Assembly Required

Min: 1

Code: E25000



17873





Versatile Racks

FLOOR & TABLETOP OPTIONS
OFFER OPTIMAL DISPLAYS; GREAT
FOR CLOSET & LAUNDRY ROOM
STORAGE AS WELL



Adjustable Arms

SLOTS ON ALL FOUR SIDES
ALLOW FOR VERSATILITY
CREATING GROUPINGS
THAT MAXIMIZE SPACE
& TELL YOUR STORY

Make it Your Own

A VARIETY OF ACCESSORIES
& SMALL HOOKS
ENABLE RETAILERS TO PEG
SMALL ITEMS AND CREATE
COMPELLING DISPLAYS





INNOVATIVE Tabletop Stands

41 A TABLETOP 4 SIDED DISPLAY WITH ADJUSTABLE ARMS

Features 6 slots per side and 12 hanging
arms - 9" long; 35.4"h x 20"w x 20"d;
Assembly Required

Black

Min: 1

Code: E08700



21622

White

(Available Mid-year)

Min: 1

Code: E08700



22501

Accessories

41 B ARMS FOR 4 SIDED TABLETOP DISPLAY

(Available Mid-year)

Pack of 4 extra metal arms for use with item
#21622 and #22501; 9"l x 2"w x 1"d

Black

Min: 1 Pack

Code: P02200



22503

White

Min: 1 Pack

Code: P02200



22502

41 C 3" MINI METAL HOOK DISPLAY

Pack of 12 hooks for use with #21622 and #22501;
3.65"l x 0.75"w x 0.75"d

Black

Min: 1 Pack

Code: P01250



21623

White

(Available Mid-year)

Min: 1 Pack

Code: P01250



21624

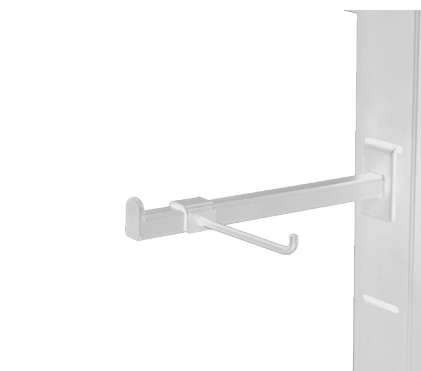
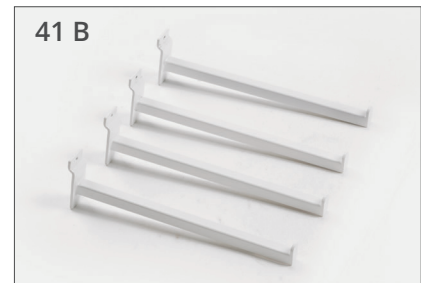

\$100
minimum order



INNOVATIVE Floor Stands



42 A

THIS GAME CHANGING RACK ALLOWS FOR DISPLAYS THAT FIT IN CORNERS, FLAT OR 360 DEGREES. COMPLETELY CUSTOMIZEABLE ACCESSORIES HELP TO CREATE POWERFUL ARRANGEMENTS THROUGHOUT YOUR STORE.

**42 A
4 SIDED 12-ARM METAL FLOOR DISPLAY RACK -
AVAILABLE IN BLACK AND WHITE**

Features 40 slots; 10 on 4 sides of the display bar. Arms can be inserted in variable slots for different hanging heights; 69”h x 29”w x 29”d; Assembly Required. Includes 12, 15” long arms. Holds up to 40 lbs. per arm. Additional arms sold separately.

Oversized; Additional Freight

Black

Min: 1 Code: E17500  4 **20581**

White

Min: 1 Code: E17500  7 **21640**

Accessories

**42 B
ADDITIONAL ARMS FOR 4-SIDED DISPLAY RACK**

(Available Mid-year)

Pack of 4, 15” metal arms for use with items #20581, #21640; 0.5”h x 15”w x 0.5”d

Black

Min: 1 pack Code: P02200  8 **20583**

White

Min: 1 Pack Code: P02200  1 **20582**

**42 C
WATERFALL ARM ACCESSORY**

(Available Mid-year)

Pack of 4 metal arms for use with items #20581, #21640; 18”l x 0.75”w x 0.75”d

White (not pictured)

Min: 1 Pack Code: P02500  8 **22518**

Black

Min: 1 Pack Code: P02500  1 **22517**

**42 D
3” MINI METAL HOOK DISPLAY**

Pack of 12 metal hooks for use with arms on items #20581 and #21640; 3.65”l x 0.75”w x 0.75”d

BLACK

Min: 1 Pack Code: P01250  0 **21623**

WHITE (not pictured)

Min: 1 Pack Code: P01250  7 **21624**



Functional | DISPLAYS AND STORAGE



FLOOR RACKS, FIXTURES & ORGANIZATION





Classic | SPIRALS

PERFECT FOR PURSES, SCARVES, CHIMES, AND MORE

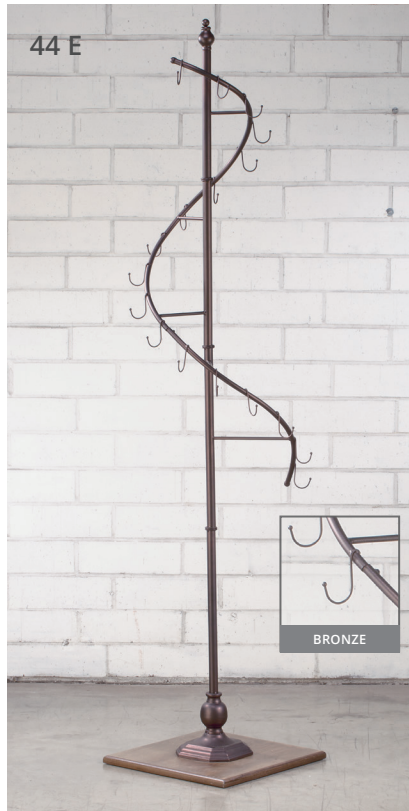



44 A
2-TIER BLACK METAL PURSE TREE

65”h x 21.75”diam, 32 Hooks; Upper Tier: 58”h,
Lower Tier: 30.5”h;
Does not spin; Assembly Required
Min: 1

Code: E14500
35995



44 B
DARK BROWN CLASSIC SPIRAL PURSE
TREE

With 1.5” Hooks; 74”h x 23”diam, 15 Hooks;
Does not spin; Assembly Required
Min: 1

Code: E12500
35990



44 C
BRONZE CLASSIC SPIRAL PURSE TREE

With 1.5” Hooks; 74”h x 23”d; 15 Hooks;
Does not spin; Assembly Required
Min: 1

Code: E12500
19830



44 D
SPINNING BRONZE SCARF TREE WITH
WOOD BASE

Wood Veneer Base; (27) 2.5” Rings; 73”h x
15.75”sq; Assembly Required
Min: 1

Code: E14800
17841



44 E
SPINNING BRONZE PURSE TREE WITH
WOOD BASE

Wood Veneer Base; 17 Hooks; 73”h x 15.75”sq;
Assembly Required
Min: 1

Code: E14800
17842



44 F
SPINNING BLACK PURSE TREE WITH
WOOD BASE

Wood Veneer Base; 17 Hooks; 73”h x 15.75”sq;
Assembly Required
Min: 1

Code: E14800
19848



45 G
FLOOR RACK WITH WOOD VENEER BASE

Hang and display your favorite scarves, blankets
and clothing with a floor rack featuring a wood
veneer base.

72”h x 33”w x 14.25”d; 1 Fixed, 3 Removable
Bars; 2 Fixed Shelves
Assembly Required

Cream

Min: 1

Code: E13000

17847



Bronze

Min: 1

Code: E13000

17846





**46 A
BRONZE METAL LADDER
FLOOR DISPLAY**

Perfect for showcasing detailed throws, quilts and towels, or for hanging clothing, jewelry, scarves and more. Wood Veneer Base, Incl. 36, 3.25"L hooks; 68.75"h x 24"w x 15"d; Assembly Required

Min: 1 Code: E18500



17844

**46 B
3.25"D BRONZE LADDER
DISPLAY HOOKS - PACK OF 6**

Add a delicate touch to your fashion display. This item is perfect for hanging necklaces, bracelets and more.

Min: 1 pack Code: P00630



17845

**46 C
ELEGANT BASE BLACK FLOOR RACK**

55.5"h x 33.5"w x 22.5"d; Assembly Required;

Oversized; Additional Freight

Min: 1 Code: E24500



16415

**46 D
4-ARM SWIVELING RACK**

Antique bronze w/ verdigris accents; 54.25"h x 35.5"dia; 17" Arm Length; Assembly Required

Min: 1 Code: E08500



16560

46 C



*Arms swivel 360°
to easily create
balanced displays*





47 A

AVAILABLE IN 3 COLORS

**47 A
PREMIER GARMENT RACK**

Top shelf: 9.75" w x 38" l; Bottom shelf: 12.5" w x 40" l; 40" Hanging Height from Top Bar; 72" h x 40" w x 17" d; Assembly Required

Dark brown

Min: 1 Code: E17500



58500

Cream

Min: 1 Code: E17500



17501

Grey

Min: 1 Code: E17500



17502

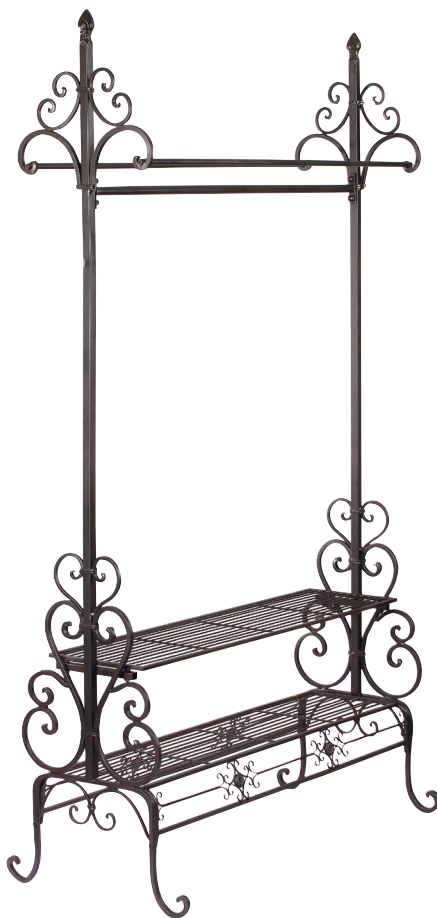

CREAM



GREY

Versatility

**DISPLAYS
TO ADJUST
TO YOUR NEEDS**

47 B

**47 B
DARK BROWN GARMENT RACK**

Shelf: 10" w x 38.5" l; 40" Hanging Height from Top Bar; 62.5" h x 40" w x 14" d; Assembly Required

Min: 1 Code: E16500



17500

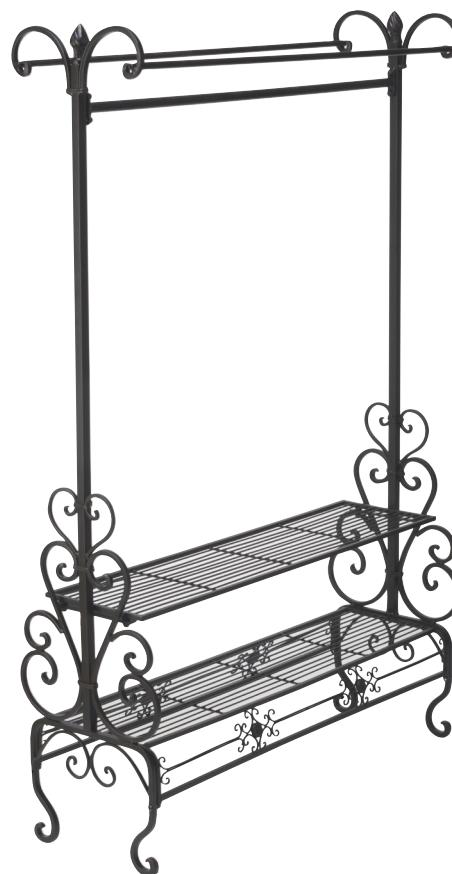

DARK BROWN

More details at tripar.com

\$100
minimum order



48 A
WATERFALL GARMENT RACK

One side waterfall, one side horizontal; Casters do not lock;
63.75"h x 29.5"w x 16"d; Assembly Required

Bronze

Min: 1

Code: E20500



19737

Black

Min: 1

Code: E20500



20544

**SIMPLE DESIGN TAKES UP
MINIMAL SPACE**

GREAT FOR IN-STORE DISPLAYS,
CLOSETS, LAUNDRY ROOMS
AND MORE!



49 A
TRIANGLE BASE METAL GARMENT RACK

Sturdy metal garment rack can hold up to 150 pounds. Can be used with or without casters. Knocks down for shipping and storage. 60”h x 48”w x 16”d; Assembly Required

White
Min: 1 Code: E13500
20584



Black
Min: 1 Code: E13500
21630



49 B
GARMENT RACK T-BAR ATTACHMENT

Use this T-Bar attachment to add more usable hanging space to the Triangle Base Garment Rack, #21630; 1.5”h x 1.5”w x 25.4”l

Black
Min: 1 Code: E01600
21626



White
Min: 1 Code: E01600
21625



STURDY & *Mobile*





Trees & HOLIDAY

BRING THE OUTDOORS IN

50 A



50 A
CREAM WHITE DEADWOOD TREE

Durable and sturdy tree; Made from molded plastic and steel.

Large

96" h x 65" w x 55" d;

Assembly Required

Min: 1 Code: E39000



21593

Medium

72" h x 46" w x 44" d; Assembly Required

Oversized; Additional Freight

Min: 1 Code: E27000



21592

Small

31" h x 16" w x 16" d

Min: 1 Code: E03250



21591



51 B

*These life like trees
create stunning focal points
at events, in stores & homes*



**51 B
NATURAL DEADWOOD TREE**

Durable and sturdy realistic tree; Made from molded plastic and steel.

Large

96"h x 65"w x 55"d;
Assembly Required

Min: 1

Code: E39000



18557

Medium

72"h x 46"w x 44"d; Assembly Required

Oversized; Additional Freight

Min: 1

Code: E27000



18556

Small

31"h x 16"w x 16"d

Min: 1

Code: E03250



18558



52 A

52 A
SET/2 TABLETOP CARD DISPLAY TREES

Spiral wires easily hold holiday cards, photos, artwork, place-cards, notes and more; Brown matte wire finish complements any decor; Assembly Required

Large: 45" h x 21.5" w x 6" d
Small: 30.5" h x 15" w x 4.5" d

Min: 1 set

Code: S06500



18611

“LIVE”

Elements

ADD DEPTH, COLOR
& TEXTURE
TO ANY SPACE



52 B

52 B
GRAY/ WHITE METAL TREES

Small Gray/White Metal Tree; 26" h x 17" dia;
Branch Spread Simple Assembly

Min: 1

Code: E06500



15361



52 C

52 C
BROWN METAL TREE

Small Textured Metal Tree; 26" h x 14" dia.
Branch Spread Simple Assembly

Min: 1

Code: E06500



35105



52 D

52 D
**WHITE DAISIES POTTED IN
WILD GRASS SET/2**

Weighted black base with realistic white PVC flowers and grass.

Small: Approx. 34" h x 6" dia base

Large: Approx. 44" h x 6" dia base

Min: 1 set

Code: S08500



18563

\$100
minimum order

ORNAMENT Trees



53 A



53 A

36" LARGE METAL TREE

36"h x 20.75"w x 19.75"d; Assembly Required

Gold

Min: 1 Code: E04300  15493



Mahogany

Min: 1 Code: E04300  15495



Silver

Min: 1 Code: E04300  15494



White

Min: 1 Code: E04300  19870



25" SMALL METAL TREE

25"h x 16.5"w x 15.5"d; Assembly Required

Gold

Min: 1 Code: E02900  15490

Mahogany

Min: 1 Code: E02900  15492

Silver

Min: 1 Code: E02900  15491

White

Min: 1 Code: E02900  19867



Ornament | UPGRADE

TABLETOP TREES



54 A

*Two toppers included:
star for holiday & ball for year round*

54 A 12-ARM TREE WITH CHANGEABLE TOPPER

12 Arm Tree; 19.25"h;
Hanging Heights -8" to 11"

Soft Silver Finish

Min: 2



Code: E02350
34141

Gold Finish

Min: 2



Code: E02350
34140

FESTIVE
&

Fun



54 B

54 B PAINTED MINI REGENT TREE

22"h; 9 Branches; 15 hanging hooks
Ideal for 4" dia pieces;
Assembly Required

Silver

Min: 1



Code: E02400
19843

Gold

Min: 1



Code: E02400
34209

UNIQUE
&

Elegant



55 C



55 C
TABLE TOP TREE

16"h x 10.75" dia, 4.875" dia Base; 11 Arms; 22 Scrolls

Black

Min: 2 Code: E02100



19841

Silver

Min: 2 Code: E02100



33175

Gold

Min: 2 Code: E02100



19840

Bronze

Min: 2 Code: E02100



19842

55 D



55 D
GOLD FOIL METAL JEWELRY TREE

Use in closets, bedroom and bathroom for beautiful storage!
Approx. 30 branches; 14.875"h x 9.75"w x 8.5"d

Min: 1



Code: E02900
19751

55 E



55 E
20" METAL TREE 12-ARM WITH 15 HOOKS

20"h x 13.5" dia Base; Hanging height starts 4.5"; 15 hooks;
Assembly Required

Gold

Min: 2 Code: E02000



34145

White

Min: 2 Code: E02000



19838

Silver

Min: 2 Code: E02000



19837



56 A

**56 A
HARP ORNAMENT STANDS**

Harp Ornament Stand; 9.75" h x 4.5" dia; 7.25" hanging height.

Gold
Min: 4 Code: E00600 0 25403 16577 4 16577

Black
Min: 4 Code: E00600 0 25403 16576 7 16576



56 B

**56 B
GOLD PAINTED FINISH DIAMOND BASE STANDS**

Small Diamond Base Stand 10" h; 7" Hanging Height
Min: 6 Code: E00600 0 25403 15384 9 15384

Large Diamond Base Stand 13" h; 9.5" Hanging Height
Min: 6 Code: E00650 0 25403 15385 8 15385



56 C

**56 C
DECORATIVE BRASS AND CHROME STANDS**

Small
6" h x 2.75" dia base; 4.75" Hanging Height
Brass
Min: 6 Code: E00140 0 25403 03926 6 23-3926B

Chrome
Min: 6 Code: E00140 0 25403 03927 3 23-3927B

Medium
7.75" h x 3.75" dia base; 6" Hanging Height
Brass
Min: 6 Code: E00170 0 25403 33936 6 23-3936

Chrome
Min: 6 Code: E00170 0 25403 33937 3 23-3937



56 D

**56 D
TWISTED BRASS FINISH WIRE STANDS**

Add a touch of elegance to holiday ornaments, jewelry and other specialty items.

Small Stand
6.75" h x 3.25" dia base; 6" Hanging Height
Min: 6 Code: E00165 0 25403 34102 4 34102

Large Stand
12" h x 5.25" dia base; 9.5" Hanging Height
Min: 6 Code: E00225 0 25403 34103 1 34103



56 E

**56 E
BRASS FINISH WIRE STANDS**

Small 7" h x 4" dia base; 5.5" Hanging Height
Min: 6 Code: E00135 0 25403 03907 5 23-3907B

Medium 8.25" h x 5.5" dia base; 6.25" Hanging Height
Min: 6 Code: E00190 0 25403 03908 2 23-3908B

Large 12.25" h x 5.5" dia base; 10.5" Hanging Height
Min: 6 Code: E00210 0 25403 33912 0 23-3912



Ornament | STANDS

UPGRADE YOUR LOOK

57 A DECORATIVE FOUR ARM STAND

Perfect for displaying ornaments for any holiday or to create beautiful year-round deco. Also can be used to hang crystals, jewelry and other small accessories. Brass Plated; 13" h x 6.25" Dia.

Hanging heights: 5.25", 6.5", 8", 9.5"
Min: 2 **Code: E00875**
34130



57 B BRASS PLATED THREE ARM ORNAMENT STAND

Brass Plated; 11" h x 5.25" Dia.
Hanging heights: 5.75", 7.5", 8.75"

Min: 2 **Code: E00425**
34122

57 C PAINTED FINISH THREE ARM STANDS

10.5" h x 4" w x 6" d; Hanging Heights 5.5", 7", 8.5"

Gold Painted
Min: 4 **Code: E00625**
34116



Silver Painted
Min: 4 **Code: E00625**
34126

SPIRAL ORNAMENT STANDS Small

Min. 12; 10" h x 5.55" w x 4.55" d

**57 D
Black Painted**
Min: 12 **Code: E00310**
35387

**57 E
Silver Painted**
Min: 12 **Code: E00310**
35380

**57 F
Brass Painted**
Min: 12 **Code: E00475**
35385

**57 G
Gold Painted**
Min: 12 **Code: E00310**
35382

Large
Min. 12; 13" h x 5.7" w x 4.4" d

**57 D
Black Painted**
Min: 12 **Code: E00375**
35388

**57 E
Silver Painted**
Min: 12 **Code: E00375**
35381

**57 F
Brass Painted**
Min: 12 **Code: E00525**
35386

**57 G
Gold Painted**
Min: 12 **Code: E00375**
35383

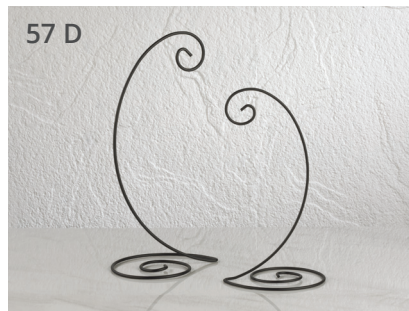

SPIRAL BOTTOM STANDS

Small: 10" h x 7.5" hh • Large: 13" h x 10" hh • Min: 12



Wreath | HANGERS

PERFECT FOR STACKING, PURSES AND MORE!

58 A



58 A
PARISIAN ADJUSTABLE WREATH HANGERS
Height range: 17.5" - 26" x 11"w x 5.25"d

Two-Tone Brown

Min: 2

Code: **E01700**
59426



Gold Parisian Wreath Hanger

Min: 2

Code: **E01700**
59416



58 B



58 B
ADJUSTABLE METAL HANGERS
Hang a purse, wreath, scarf or more
Height range: 17.5-24"h x 6.75"w x 6.75"d

Cream Metal Hanger

Min: 1

Code: **E02000**
17848



Oil Rubbed Bronze Metal Hanger

Min: 1

Code: **E02000**
17849



58 C



58 C
BROWN TWISTED MOTIF ADJUSTABLE WREATH HANGER

Height range: 14.5" - 27" ;
Adjustable Hook Height x 8" dia

Min: 2

Code: **E01475**



58942

58 D



58 D
OVER-THE-DOOR WREATH HOOK
18"h x 1.75"w; Wreath hanging hook

Brown

Min: 6

Code: **E00330**
33308



Gold

Min: 6

Code: **E00330**
33300



58 E



58 E
SINGLE HOOK ADJUSTABLE TABLETOP DISPLAY

(Available Mid-year)

Height range from 15" - 27" tall with a 2.25" long hook and 5" x 5" base. 15.25"h x 5"w x 5"d

Assembly Required

Min: 1

Code: **E02400**
22652



58 F



58 F
ADJUSTABLE DOUBLE SIDED METAL WREATH HANGER - EXTRA TALL

(Available Mid-year)

Great for wreaths, purses, scarves and more.
Adjusts from 35.5" to 60" tall 36"h x 7"w x 7"d

Black

Min: 2

Code: **E03300**



22616

White

Min: 2

Code: **E03300**



22615



Beautiful
HOME



Tripair Products
ARE PERFECT
ACCESSORIES FOR ANY
OCCASION

PRICE IT,
TAG IT,
Sell it





Multi-Use | STANDS

PLATTERS, PLATES & BOWLS



60 A

SQUARE WIRE BOWL/PLATTER STANDS

Fits especially large platters with elevated base to accommodate large curves.

Large Bowl/Platter Stand;

11.25"h x 10"w x 6.75"d; 4.875" Bracket Depth

Gold

(Available Mid-year)

Min: 2



Code: E00900
22565

White

(Available Mid-year)

Min: 2



Code: E00900
22567

Black

Min: 2



Code: E00900
59882

Small Bowl/Platter Stand;

9"h x 8.5"w x 6"d; 4.5" Bracket Depth

Black

Min: 2



Code: E00675
59881

White

(Available Mid-year)

Min: 2



Code: E00675
22566

Gold

(Available Mid-year)

Min: 2



Code: E00675
22564

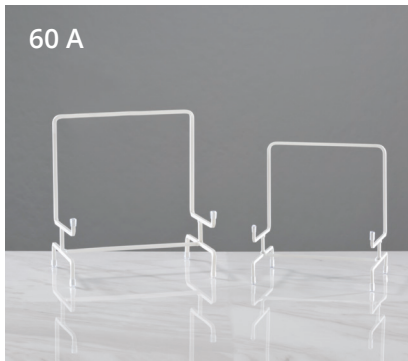

*Great home organizers for:
bakeware • bowls • serving platters*



60 B

SQUARE WIRE KELLER BOWL STAND

Heavier and wider than our Stratford Stands and will hold heavy, thick ceramic or glass.

Small Black Bowl Stand

7"h x 7.5"w x 5.5"d

Min: 4



Code: E00675
56231

Large Black Bowl Stand

9"h x 10.15"w x 7.75"d

Min: 4



Code: E00950
56232

**STRONG
&
Stylish**



**61 A
STRATFORD BOWL STANDS**

Easily and elegantly holds deep items such as bowls, heavy tiles, trays, framed pictures and much more.

Large Bowl Stand
9" h x 10"w x 7.5"d; 6.75" lip

Gold
Min: 2 Code: E00700
55782

Black
Min: 2 Code: E00700
55882

Small Bowl Stand
7" h x 7.5"w x 5.75"d; 5" lip

Gold
Min: 3 Code: E00450
55781

Black
Min: 3 Code: E00450
55881



These sturdy stands are great for large platters

**61 B
YORK BOWL/PLATTER STANDS
COPPER & BLACK**

Small York Bowl/Platter Stand;
11"h x 6.5"w x 6.5"d, 4.75"d Bracket

Min: 4 Code: E00350
54531

Large York Bowl/Platter Stand;
12.25"h x 8"w x 8.25"d, 5.75"d Bracket

Min: 4 Code: E00450
54532

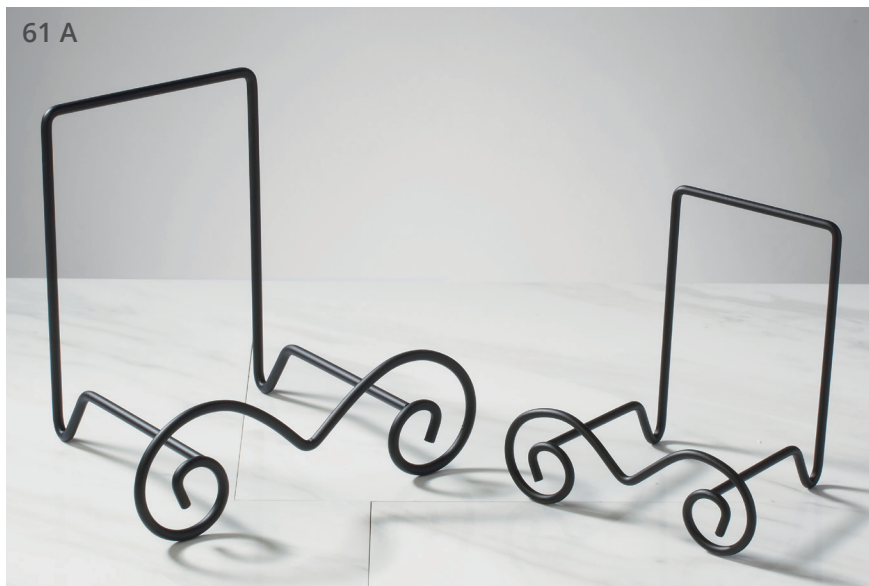



62 A

62 A
KELLER 5-TIER PILLAR HOLDER
6.5" h x 21.5" w x 5" d; 3.5" dia. candle platform
Min: 2 **Code: E03375**
56275 **56275**



62 B

62 B
KELLER 3-TIER SWIVEL PLATE STAND
15.75" h x 24" w x 24" d;
accommodates 3- 8.25" to 11" dia. plates
Min: 3 **Code: E002100**
56265 **56265**



62 C

62 C
4-ARM MUG STAND
15.75" h x 7.75" dia.
White
Min: 2 **Code: E00975**
19845 **19845**
Mahogany
Min: 2 **Code: E00975**
55334 **55334**



62 D

62 D
4-ARM MUG STAND
17.25" h x 8.25" dia
Mahogany
Min: 4 **Code: E01175**
55464 **55464**
Black
Min: 4 **Code: E01175**
19846 **19846**

62 E
LITTLE BIRD 4-PLACE MUG STAND - BROWN
15.5" h x 9" w x 9" d
Min: 1 **Code: E01650**
19647 **19647**



62 E



63 A
PLATE DISPLAY RACK

(Available Mid-year)

Perfect for organizing and displaying plates, cutting boards, platters, books, magazines, mail and more.

10 slots; 7.75" h x 14.75" w x 5.25" d

Min: 2 **Code: E02500**
22595



63 B
YORK STAIRSTEP STAND COPPER FINISH W/ BLACK ACCENTS

York 4 Place Step Stand;

14.5" h x 7.5" w x 8.25" d; 1.75" Bracket Depth

Min: 2 **Code: E00925**
54567



63 C
BLACK AUGUSTA STAIRSTEP STAND

4 Place Augusta Stair Step Stand:

12.5" h x 5.25" w x 9.5" d, 1.5" d Bracket

Min: 4 **Code: E00675**
59887



63 D
CIRCULAR PLATE RACK - WHITE

(Available Mid-year)

Rustic white painted finish.

20 slots. 6.25" h x 16" dia.

Min: 1 **Code: E04500**
22596



63 E
ELONGATED DISPLAY RACK

Extra long to fit even more. Rustic painted finish.

7.75" h x 29.8" w x 5" d

Min: 1 **Code: E04400**
19740



63 F
BALDWIN METAL MULTI-PLATE STAND
Mahogany

4 Plate Holder; 6" h x 7" w x 7.25" d;

1.75" d bracket for 8"-11" dia. plates

Min: 2 **Code: E00725**
55404



6 Plate Holder; 6.5" h x 6.75" w x 10.75" d; 1.75" d

Bracket for 8"-11" dia plates
Min: 2 **Code: E01000**
55406



63 E

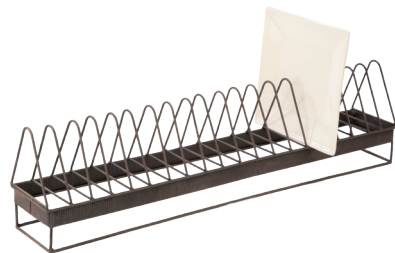

Extra long single rack

63 G
WOODEN MULTI-PLATE STAND
Walnut finish

6 slots - 1.5" spacing

3" h x 4.5" w x 11.5" d

Min: 2 **Code: E01075**
33905



Natural finish

6 slots - 1.5" spacing

3" h x 4.5" w x 11.5" d;

Min: 2 **Code: E01075**
33907





64 A



64 B



64 C



64 D



64 E



**64 A
BRASS FINISH TWISTED WIRE CUP
& SAUCER STAND**

Fits standard cup sizes; 6.25" h x 2.25" w x 3" d.

Min: 6

Code: E00215



23-2455 **R**

**64 B
BRASS FINISH SMOOTH WIRE CUP &
SAUCER STAND**

Smooth Brass Finish

Standard - 6.25" h x 2.25" w x 2.75" d

Min: 6

Code: E00160



23-2450 **R**

**64 C
ETCHED BASE CUP & SAUCER STAND**

Brass Finish

Fits standard cup sizes; 3.5" h x 2.75" w x 4.25" d

Min: 6

Code: E00240



23-2452 **R**

**64 D
BRASS FINISH VICTORIAN TWISTED
WIRE CUP & SAUCER STAND**

Twisted Brass Finish

Fits standard cup sizes; 6.5" h x 3.5" w x 2.75" d

Min: 6

Code: E00220



23-2459 **R**

**64 E
CLEAR ACRYLIC CUP & SAUCER STAND**

Bulk; No packaging

Individual pieces are not barcoded.

1.75" h x 4.75" w x 3" d

Min: 12

Code: E00135



20-2404B

Cups & Saucer | DISPLAYS

GREAT HOME ORGANIZERS



KITCHEN ESSENTIALS - BOWL, MUG & SPECIALTY STANDS

65 A



65 B



65 A

10-HOOK MUG WALL PACK

Great wall storage solution. Space between top row of hooks and bottom row of hooks is 6.75". 13"h x 26.25"w x 2.25"d

Min: 1 Code: E03300



20504

65 B

4-PLACE VERTICAL AUGUSTA CUP & SAUCER WALL RACKS

Square wire construction; 36"h x 5.25"w x 3"d

Antique White Cup / Saucer Rack

Min: 2 Code: E01500



59957 **R**

Black Cup / Saucer Wall Rack

Min: 2 Code: E01500



59857 **R**

CREATIVE
&

Unique



Decorative | WALL RACKS

GREAT FOR FRAMED PHOTOS & DECORATIVE PLATES

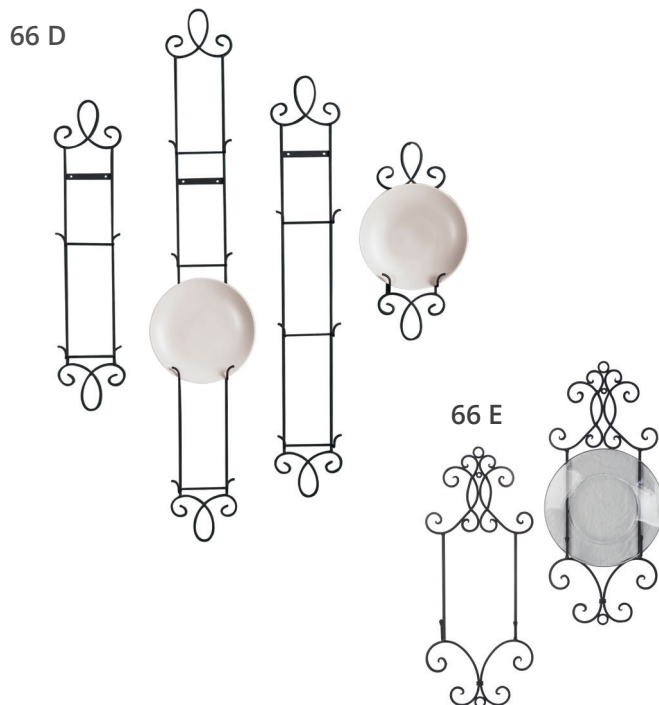
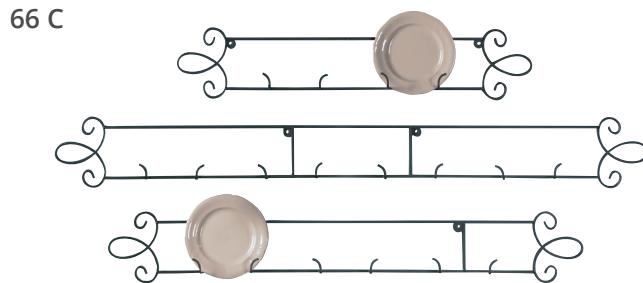
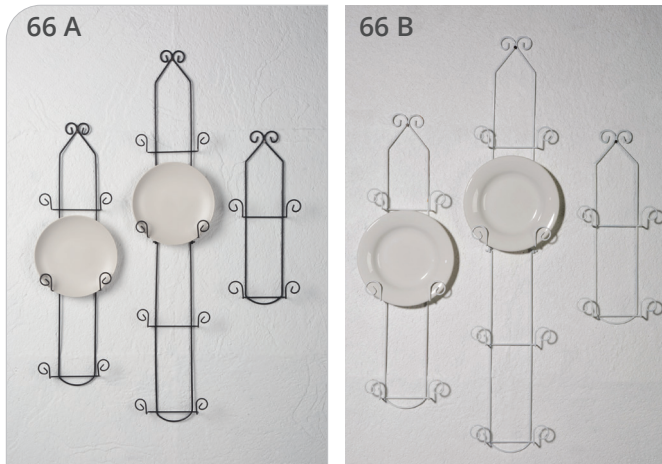

\$100
minimum order

66 A

BLACK ECONOMY WALL RACKS

2 Plate Black; 17.75" h x 7.25" w x 1.75" d; Holds two 8" plates

Min: 4 Code: E00525  21519

3 Plate Black; 27" h x 7.25" w x 1.75" d; Holds three 8" plates

Min: 4 Code: E00665  59213

4 Plate Black; 38" h x 7.25" w x 2" d; Holds four 8" plates;

Assembly Required

Min: 4 Code: E00775  59214

66 B

WHITE ECONOMY WALL RACKS

2 Plate White; 17.75" h x 7.25" w x 1.75" d; Holds two 8" plates

Min: 4 Code: E00525  21516

3 Plate White; 27" h x 7.25" w x 1.75" d; Holds three 8" plates

Min: 4 Code: E00665  21517

4 Plate White; 38" h x 7.25" w x 2" d; Holds four 8" plates;

Assembly Required

Min: 4 Code: E00775  21518

66 C

HORIZONTAL BLACK AUGUSTA WALL RACKS

Uniquely display plates, china, artwork, tiles and much more.

Holds Plates, 6.5"-8.25" dia; 5" Bracket Spacing; 1.75" Bracket

Depth

2 Place Horizontal Black Rack

5.25" h x 27" w x 2" d

Min: 4 Code: E00950  59836

3 Place Horizontal Black Rack

5.25" h x 36" w x 2" d

Min: 4 Code: E01150  59837

4 Place Horizontal Black Rack

5.25" h x 44.75" w x 2.25" d

Min: 4 Code: E01450  59838

66 D

NARROW AUGUSTA VERTICAL WALL RACKS

Holds Plates 6.5" x 8.25" dia; 9" Bracket Spacing; 1.75" Bracket Depth

Narrow 1-Tier Black Vertical Rack; 16" h x 5.25" w x 2" d

Min: 6 Code: E00575  59851

Narrow 2-Tier Black Vertical Rack; 25" h x 5.25" w x 2" d

Min: 4 Code: E00800  59852

Narrow 3-Tier Black Vertical Rack; 34" h x 5.25" w x 2" d

Min: 4 Code: E00975  59853

Narrow 4-Tier Black Vertical Rack; 42.75" h x 5.2" w x 2" d

Min: 4 Code: E01200  59854

66 E

CHELSEA PLATE/FRAME WALL RACK

Stylishly display plates, tiles, artwork and much more.

The piece is complete with vintage scroll accents.

22.25" h x 9" w x 2" d; 1.5" Lip, Ideal for items 10-14"

Min: 2 Code: E01200  59440

Wall & TABLE STANDS

FUNCTIONAL YET ELEGANT



KITCHEN ESSENTIALS - BOWL, MUG & SPECIALTY STANDS

67 A

BALL TIP STANDS - WALL & TABLE TOP

Display plates, tiles, artwork bowls, and plates. These stands feature ball tips and a painted finish and will accent any surface.

Small Black

Ball Tip Stand (Wall only); 5.5"h x 3.25"w x 2"d; Ideal for 6" - 10" Items

Min: 6 Code: E00285  43006

Small Steel

Min: 6 Code: E00285  43007

Large Black

Ball Tip (Wall Stand); 8"h x 4.5"w x 4.5"d; Ideal for 10" - 16" Items

Min: 4 Code: E00475  43016

Large Steel

Min: 4 Code: E00475  43017

Large White (large size only)

Min: 4 Code: E00475  19835



67 B

LOOP DESIGN STANDS - WALL & TABLE TOP

Elegantly display plates, memory books and much more. The basic loop design with a dark brown finish will accentuate and complement any item.

Small Brown Loop Design Stand

5.5"h x 4.75"w x 3.5"d; 3"d Bracket

Min: 6 Code: E00510  43005

Large

Loop Design Stand

8"h x 5.75"w x 4.25"d; 3.5"d Bracket

Brown

Min: 4 Code: E00650  43015

Black

Min: 4 Code: E00650  19833

Charcoal

Min: 4 Code: E00650  19832



67 B

BROWN

CHARCOAL

BLACK



67 C

SCROLL STANDS - WALL & TABLE TOP

Small

5.5"h x 7"w x 3.5"d

Black

Min: 6 Code: E00475  43001

Charcoal

Min: 6 Code: E00475  43002

Large

8"h x 8"w x 4.75"d

Black

Min: 4 Code: E00625  43011

Large Charcoal

Min: 4 Code: E00625  43012



67 C



67 D



Tripar's Famous | PLATE WIRES





SETTING THE INDUSTRY STANDARD



68 A

BRASS FINISH PLATE WIRES **R**

High grade steel springs. Comes with clear coated tips.
Suggested weight 2 lbs. Easy Fit Guarantee. Hook and nail included.

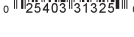
ITEM	FITS ITEMS	MIN	CODE
 23-1303	3" - 5"	12	E00120
 23-1305	5" - 7"	12	E00125
 23-1307	7.5" - 9.5"	12	E00135
 23-1310	10" - 14"	12	E00180
 23-1311	14" - 20"	12	E00190
 23-1325	15" - 30"	6	E00400

68 A





68 B



68 B

WHITE PLATE WIRES **R**

High grade steel springs. Comes with clear coated tip.
Suggested weight 2 lbs. Easy Fit Guarantee. Hook and nail included.

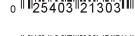
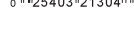
ITEM	FITS ITEMS	MIN	CODE
 32-1301	3.5" - 5"	12	E00120
 32-1302	5" - 7.5"	12	E00125
 32-1303	7.5" - 9.5"	12	E00130
 32-1304	10" - 14"	12	E00145



Pictured platter 19" x 14"



69 C

ECONOMIC PLATE HANGERS **R**

These Plate Hangers are an exceptional economic value. No coating on the tips. Holds up to 1 lb.

	ITEM	FITS ITEMS	MIN	CODE
	10200	5" - 7"	12	E00085
	10202	7" - 10"	12	E00090
	10204	10" - 14"	12	E00095
	10206	14" - 18"	12	E00125
	10208	5" - 11"	12	E00095

69 C



69 D



69 D

SUPER HANGERS **R**

Super Hangers are made with strong, white powder-coated metal. Ideal for larger plates, platters and plaques. Hook and nail included.

	ITEM	FITS ITEMS	MIN	CODE
	31-1316	13" - 16" Holds up to 4.5 lbs	6	E00440
	31-1318	15" - 20" Holds up to 5.5 lbs	6	E00500
	31-1319	19" - 24" Holds up to 6.25 lbs	6	E00520

R Retail Packaging has a two-color decorative card with product description and usage information. It is designed for hanging display.



Beautiful Kitchen & BUFFET

EFFORTLESS ENTERTAINING

**70 A****SWIRL DESIGN METAL COOKBOOK STAND**Features weighted chain page holders and folding easel back.
13.5"h x 13"w x 9.75"d; 2" Shelf Depth**White:** Min: 2 Code: E01500  19825**Cooper:** Min: 2 Code: E01500  19826**Brown:** Min: 2 Code: E01500  58915**Black:** Min: 2 Code: E01500  19828**71 B****METAL DIAMOND COOKBOOK STAND**

Features folding easel back; 2" Shelf Depth; 7.5"h x 10.5"w x 8"d

Min: 1 Code: E01100  20596**71 C****DARK GREY METAL WAVE COOKBOOK STAND**

Features folding easel back; 2" Shelf Depth; 7.5"h x 10.75"w x 7.75"d

Min: 1 Code: E01100  20595**71 D****BALDWIN METAL COOKBOOK STAND**Features weighted chain page-holders; 13.5"h x 12.5"w x 8.75"d
2" Shelf DepthMin: 2 Code: E01500  55425**71 E****BLACK METAL SCALLOPED COOKBOOK STAND**

Features weighted chain page holders; 11.75"h x 13.5"w x 9.25"d

Min: 2 Code: E01250  19680**71 F****CREAM METAL COOKBOOK STAND**Features weighted chain page holders;
13.25"h x 12.5"w x 9.75"d; 2.25"d ShelfMin: 2 Code: E01500  58512**71 G****BLUE METAL WAVE COOKBOOK STAND**

Features folding easel back; 2" Shelf Depth; 7.5"h x 10.75"w x 7.75"d

Min: 1 Code: E01100  21675**71 H****METAL GEOMETRIC COOKBOOK STAND**

Features folding easel back; 2" Shelf Depth; 7.75"h x 10.75"w x 8"d

Min: 1 Code: E01100  20597



Hands Free
RECIPES
AT A GLANCE



Convenient
FOR BUSY
HOME COOKING





Large | FLOOR EASELS

TIMELESS ELEGANCE



CLASSIC BLACK & ELEGANT GOLD

Easels

72 A FLOOR EASEL

Lip depth 4" wide; adjustable brackets;
65"h x 21.5"w x 25"d;
Holds up to 25lbs.

Gold
(Available Mid-year)

Min: 1

Code: E08600
22570

Black
Min: 1

Code: E08600
56200

72 B 24" TABLE TOP EASEL

Lip depth 2.25" wide; adjustable brackets;
24"h x 12.25"w x 10"d
Holds up to 10lbs.

Gold
(Available Mid-year)

Min: 1

Code: E01900
22571

Black
Min: 1

Code: E01900
56216

72 C 36" TABLE TOP EASEL

Lip depth 2.25" wide; adjustable brackets;
36"h x 14.25"w x 17.25"d
Holds up to 25lbs.

Gold
(Available Mid-year)

Min: 1

Code: E03400
22572

Black
Min: 1

Code: E03400
56217





**73 A
EXTRA LARGE MAHOGANY
FLOOR EASEL**

3 Bracket Mounting Locations:
12"h, 26"h, 40"h; 20 pound limit
3.25" Bracket Depth; 69"h x 18"w x 26"d

Oversized; Additional Freight

Min: 1 Code: E07200
58800



**73 B
NATURAL FLOOR EASEL BROWN**

Holds Artwork up to 39"h *with Adjustable
Brackets*; 56"h x 19.75"w x 28"d. Holds up to 20lbs;
2.5" Bracket Depth

Oversized; Additional Freight

Min: 1 Code: E07900
56000



**SOPHISTICATED
&**

Simple

ADJUSTABLE
WITH MODULAR
VERSATILITY

**73 C
DECORATIVE FLOOR EASEL**

Square Metal *with Adjustable Brackets*
Black and Gold Accents
53.5"h x 16.25"w x 18.25"d; 3"d Bracket; Holds
up to 25lbs;

Oversized; Additional Freight

Gold
Min: 1 Code: E04800
59404



Black
Min: 1 Code: E04800
19847





FLOOR Easels



74 A MULTI-PICTURE ADJUSTABLE FLOOR EASEL

Easel features fixed bottom brackets and **two sets of adjustable brackets**. Holds up to 3 pictures/boards. Brackets are 2" deep. Holds up to 60 lbs. Folds for storage. 67.5"h x 26.75"w x 17.25"d

Oversized; Additional Freight

Min: 1

Code: E08000
20506



74 B 40" GOLD METAL EASEL

Bracket is 6.25" from ground. Folds for storage. 2" lip depth. Bracket is not adjustable 40"h x 10"w x 25"d

Min: 1

Code: E02900
20591



74 C REGAL FLOOR EASEL

Features Fleur-de-Lis Handles *with Adjustable Brackets* 56.5"h x 18.5"w x 37"d; 1.75"d Lip Holds up to 15lbs; Assembly Required

Oversized; Additional Freight

Min: 1

Code: E05500
16498



74 D BALDWIN FOLDING FLOOR EASEL - MAHOGANY

47.5"h x 21"w x 21"d 29" Clearance from brackets to top Holds up to 25 lbs; Folds flat for storage

Oversized; Additional Freight

Min: 1

Code: E04900
55400



74 E EXTRA TALL BLACK FLOOR EASEL

65"h x 22.25"w x 29"d 3"d Adjustable Bracket 15lb. limit; Assembly Required

Min: 1

Code: E04500
58165





75 A
BOW MULTI PICTURE FLOOR
EASEL - GOLD

Comes with 2 sets of brackets with adjustable placement along easel. Hold up to 2 pictures/posters. Lip depth 2.25"; 53.5"h x 20.5"w x 22.5"d

Oversized; Additional Freight

Min: 1

Code: E07200
20574



75 B
LADDER FLOOR EASEL - BLACK

Includes 1 set of adjustable brackets. Lip depth 2.25" wide; Folds flat for storage. 54"h x 18.8"w x 21.25"d

Oversized; Additional Freight

Min: 1

Code: E07000
20577



KITCHEN TOWELS
AVAILABLE AT WINE WINKS

75 C
KELLER FLOOR EASEL

Square Metal *with Adjustable Brackets*
Lip depth 4" wide; 66"h x 21.5"w x 25"d
Holds up to 25lbs.

Gold
(Available Mid-year)

Min: 1

Code: E08600
22570



Black

Min: 1

Code: E08600
56200



STURDY
&
Timeless



Acrylic | STANDS







CLASSIC TABLE TOP STANDS





76 A

76 A CLASSIC ACRYLIC PLATE STANDS

Design allows for 90 degree opening and flat storage.

- 4.5" Classic Stand - Fits Items 3" - 6"
Min: 12 Code: E00225  32-1201 **R**
- 7" Classic Stand - Fits Items 6" - 10"
Min: 12 Code: E00290  32-1202 **R**
- 9" Classic Stand - Fits Items 8" - 12"
Min: 6 Code: E00430  32-0209 **R**
- 4.5" Classic Stand
Min: 12 Code: E00170  32-1201B **B**
- 7" Classic Stand
Min: 12 Code: E00245  32-1202B **B**
- 9" Classic Stand
Min: 6 Code: E00325  32-0209B **B**

76 B HINGED ACRYLIC STANDS

- 5" Ebony Acrylic Stand; Fits items 4" - 7"
Min: 6 Code: E00100  65-1220 **B**
- 7" Ebony Acrylic Stand; Fits items 6" - 10"
Min: 6 Code: E00135  65-1221 **B**
- 9" Ebony Acrylic Stand; Fits items 8" - 12"
Min: 6 Code: E00205  65-1222 **B**
- 9" Frosted Acrylic Stand; Fits items 8" - 12"
Min: 6 Code: E00205  65-1209 **B**

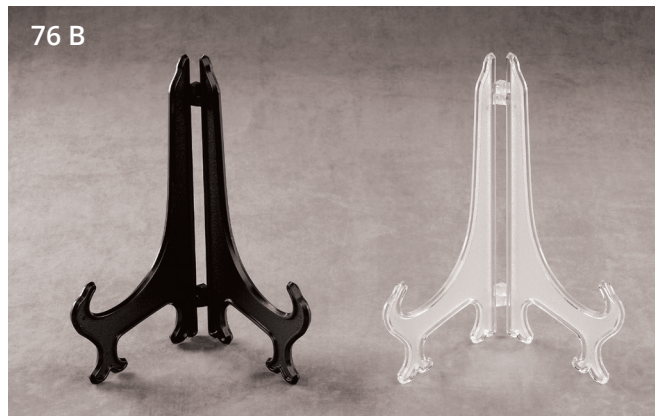

76 B

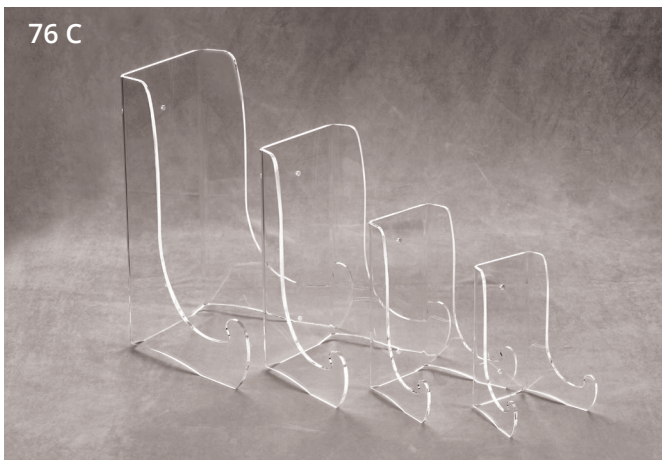

76 C



76 C LARGE ACRYLIC BOWL & PLATTER STANDS

Table Top or Wall Hanging. 7.5" Wall/ Table Top Stand
Holds items 8" - 11"; Up to 2.5"d, 10 lbs weight limit

- Min: 1 Code: E01525  44314 **B**
- 9" Wall/ Table Top Stand
Holds items 10" - 13"; Up to 3"d, 12 lbs weight limit
Min: 1 Code: E02125  44316 **B**
- 12" Wall/ Table Top Stand
Holds items 13" - 20"; Up to 3.75"d, 14 lbs weight limit
Min: 1 Code: E02800  44318 **B**
- 15" Wall/ Table Top Stand
Holds items 16" - 24"; Up to 4.5"d, 16 lbs weight limit
Min: 1 Code: E03800  44320 **B**

76 D MINI ACRYLIC STANDS

No packaging: Individual pieces are not barcoded. Ideal for collectors items like coins & framed stamps.

- 2" h, Fits items 2" - 5" - Lip 1/4" d
Min: 12 Code: E00080  44306
- 1.5" h, Fits items 1" - 4" - Lip 3/16" d
Min: 12 Code: E00070  44304

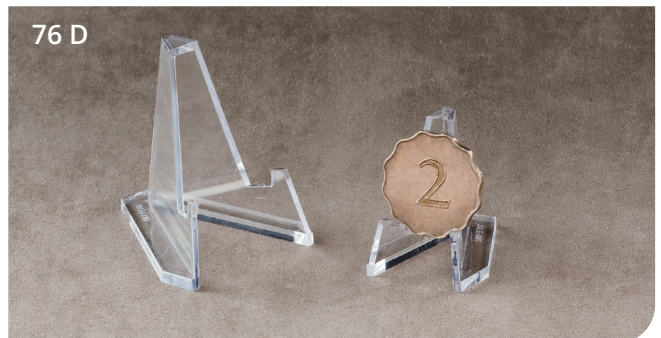

76 D



77 E

77 E

CLASSIC CLEAR ACRYLIC HINGELESS PLATE STANDS

Single molded piece. Not packaged for hanging display.

6" Acrylic Hingeless Stand

Min: 12

Code: E00475

74316 **B****8.75" Acrylic Hingeless Stand**

Min: 6

Code: E00825

74318 **B**

77 F

ELEGANT DISPLAY EASELS

Versatile & inexpensive easels. Best for flat items.

No Packaging: Individual pieces are not barcoded.**4.5" h x 4.875" w x 4.25" d; Fits items 6.5" - 10.5"**

Min: 12

Code: E00375



44268

3.5" h x 3.875" w x 2.875" d; Fits items 5" - 8.5"

Min: 12

Code: E00260



44266

3" h x 2.875" w x 2.5" d; Fits items 4" - 6"

Min: 12

Code: E00230



44264

2.25" h x 2.25" w x 2.125" d; Fits items 3" - 5"

Min: 12

Code: E00200



44262

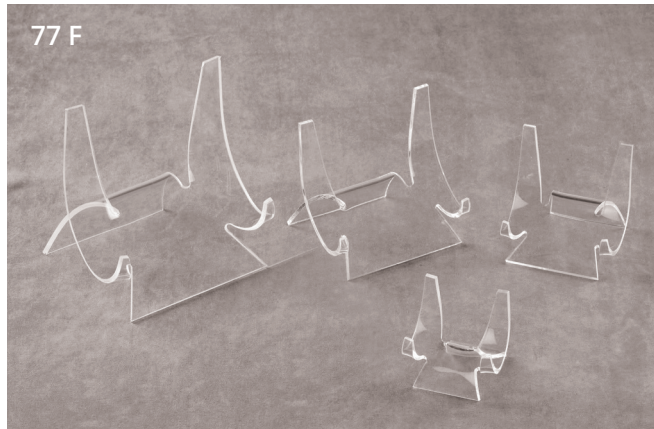

77 F

77 G

77 G

ACRYLIC CADDY

Versatile acrylic stand. Holds a wide variety of plates, plaques and trays

8" h Fits items 8" - 18"; Lip 2.5" d

Min: 6

Code: E00700

23-1258 **B****6" h**, Fits items 6.5" - 14"; Lip 2.25" d

Min: 6

Code: E00625

23-1256 **B****4" h**, Fits items 4.5" - 11"; Lip 2" d

Min: 6

Code: E00525

23-1254 **B****3" h**, Fits items 2.5" - 5"; Lip 1" d

Min: 6

Code: E00425

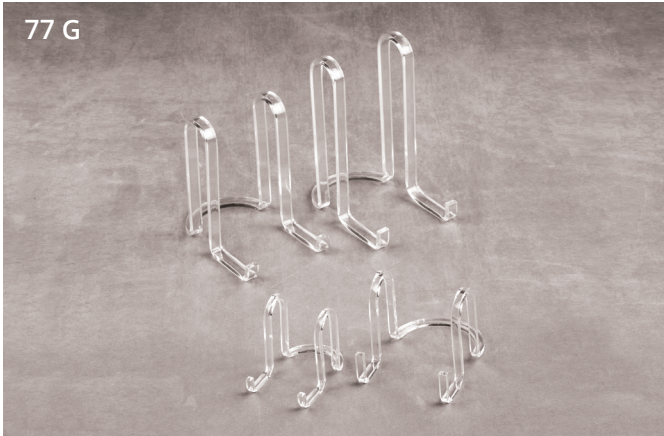
23-1253 **B**

77 H

CLEAR ACRYLIC STANDS**5" Clear Acrylic Stand**

Fits Items 7"-11"

5" h x 3.5" w x 5" d, 3.125" d Bracket

Min: 6

Code: E00525

74321 **B****8" Clear Acrylic Stand,**

Fits Items 11"-18"

8" h x 5.5" w x 7.25" d, 4.75" d Bracket

Min: 4

Code: E01050

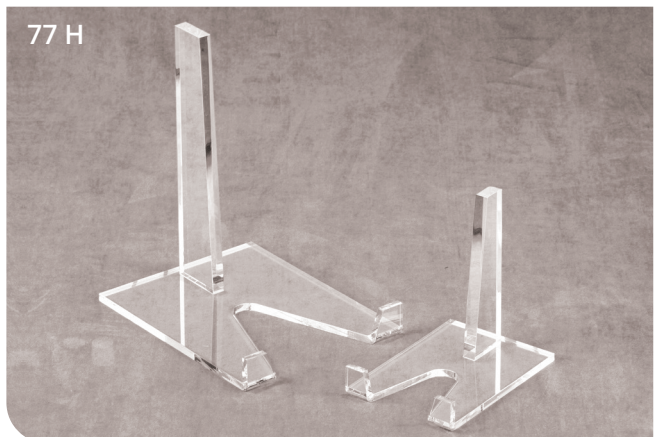
74322 **B**

77 H



Decorative | EASELS



78 A

78 A KELLER EASELS

Small Keller Table-Top Easel 11" h x 5" w x 7.5" d;
1.5" lip Ideal for 8" items

Gold
(Available Mid-year)

Min: 2
0 25403 22573 7

Code: E00835
22573

Black
Min: 2
0 25403 56211 5

Code: E00835
56211

Large Keller Table-Top Easel 14" h x 6" w x 9" d;
1.5" lip Ideal for 10.5" items

Gold
(Available Mid-year)

Min: 2
0 25403 22574 4

Code: E00975
22574

Black
Min: 2
0 25403 56215 3

Code: E00975
56215



78 A

78 B MAHOGANY FINISH CAST IRON MOTIF STAND

4.5" h x 5.25" w x 3.5" d, 2.5" Bracket Depth; Fits
6"-11" items

Min: 6
0 25403 55435 6

Code: E00375
55435

78 C 9" H DISTRESSED WHITE EASEL WITH CAST IRON DESIGN

9" h x 6" w x 7.5" d, 1.75" Bracket Depth;
Ideal for 8"-12" items

Min: 4
0 25403 58156 7

Code: E00575
58156



78 B



78 C



79 A
BLACK TABLETOP METAL A-LINE EASELS

Large 10.75" h x 8.25" w x 7.25" d, 1" lip

Min: 2 **Code: E00700**  **20513**

Small 9.4" h x 7.25" w x 8" d, 1" lip

Min: 2 **Code: E00575**  **20512**



79 B
YORK EASELS
COPPER FINISH WITH BLACK ACCENTS

Large
14" h X 8.25" w X 9" d 1.5" d Bracket - Fits 9"- 11" Items

Min: 4 **Code: E00550**  **58214**

Small
11.25" h X 6.25" w X 8" d 1.5" d Bracket - Fits 7"- 9" Items

Min: 6 **Code: E00450**  **58215**



CAT EASELS
Display your favorite cards, plates and pictures using this cute, yet sturdy cat easels.

79 C
Large 14" h x 9.15" w x 8.55" d, 1" lip

Min: 2 **Code: E00800**  **19682**

79 D
Small 11.3" h x 8.15" w x 7" d, 1" lip

Min: 2 **Code: E00700**  **19681**

79 E
TABLETOP 13" METAL BAMBOO EASEL
Bamboo inspired design in burnished gold finish. Lip depth .875"
12.75" h x 6." w x 7.25" d

Min: 2 **Code: E01400**  **20571**

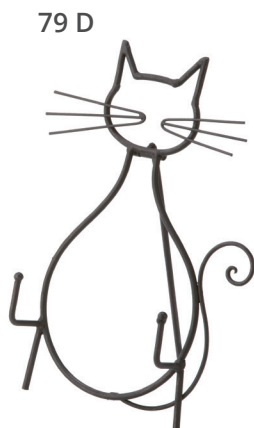
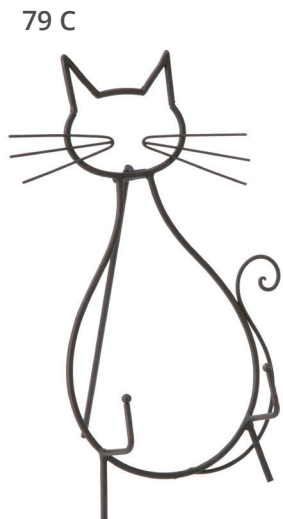



Stands & EASELS

DEFINING THE STANDARD

80 A



80 A

MAHOGANY BALDWIN FOLDING EASELS

Small: 9.25" h x 8.5" w x 8" d

Min: 4

Code: E00475



55408

Medium: 13" h x 10" w x 9.75" d

Min: 4

Code: E00675



55411

Large: 16.4" h x 12.5" w x 11.95" d

Min: 2

Code: E00925



55416

X-Large: 20.15" h x 13.9" w x 14.5" d

Min: 2

Code: E01075



55419

80 B



80 B

MODERN BLACK TRIPOD EASELS

Our modern black tripod easels are a simple yet decorative way to display pictures, plates, and much more.

Small: 7.25" h x 5" w x 4" d; 3" Bracket Depth;

Ideal for 5" - 9" items

Min: 4

Code: E00525



55312

Medium: 10" h x 6" w x 4" d; 4" Bracket Depth;

Ideal for 8" - 12" items

Min: 4

Code: E00575



55313

Large: 12" h x 7.25" w x 5" d; 4.25" Bracket Depth;

Ideal for 9" - 15" items

Min: 4

Code: E00650



55314

80 C



80 C

MAHOGANY TRIPOD FOLDING EASELS

Stylishly display plates, picture frames, artwork, signage and much more.

Small: 8.25" h x 7" w x 4.75" d; 4.125" d Bracket Depth;

Ideal for 6" - 9" items

Min: 6

Code: E00400



55451

Medium: 10.25" h x 8" w x 6" d; 5.25" d Bracket Depth ;

Ideal for 9" - 12" items

Min: 4

Code: E00475



55452

Large: 13.5" h x 9" w x 6" d; 5.875" d Bracket Depth;

Ideal for 12" - 14" items

Min: 4

Code: E00500



55453



81 A
STRAIGHT EDGE GOLD EASELS

(Available Mid-year)

- Small:** 6.45"h x 5.45"w x 5.15"d, 1.375"d lip
Min: 6 Code: E00520  22575
- Medium:** 9.5"h x 5.25"w x 7"d, 1.375"d lip
Min: 3 Code: E00565  22576
- Large:** 12"h x 7.5"w x 7.85"d, 1.375"d lip
Min: 3 Code: E00630  22577
- X-Large:** 14.75"h x 8.55"w x 8.15"d, 2"d lip
Min: 3 Code: E00780  22578



81 B
STRAIGHT EDGE BLACK EASELS

- Small:** 6.5"h x 5.45"w x 5.15"d, 1.375"d lip
Min: 6 Code: E00520  43302
- Medium:** 9.5"h x 5.25"w x 7"d, 1.375"d lip
Min: 3 Code: E00565  43303
- Large:** 12"h x 7.5"w x 7.85"d, 1.375"d lip
Min: 3 Code: E00630  43304
- X-Large:** 14.75"h x 8.55"w x 8.15"d, 2"d lip
Min: 3 Code: E00780  43305

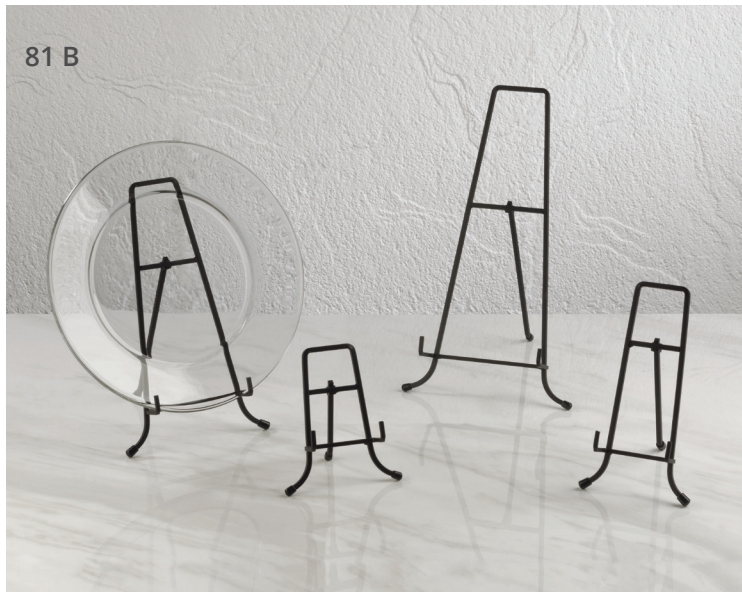

81 C
TRADITIONAL ART EASELS IN BLACK

- Small:** 5.35"h x 2.85"w x 4.75"d, 1"d lip
Min: 6 Code: E00500  23-1291
- Medium:** 9.25"h x 4.65"w x 5.75"d, 1"d lip
Min: 6 Code: E00600  23-1292
- Large:** 13.15"h x 6.5"w x 9.25"d, 1.5" lip
Min: 1 Code: E00865  23-1295
- X-Large:** 23.75"h x 11.25"w x 16.15"d, 1.5" Lip
Min: 1 Code: E01790  23-1297



\$100
minimum order

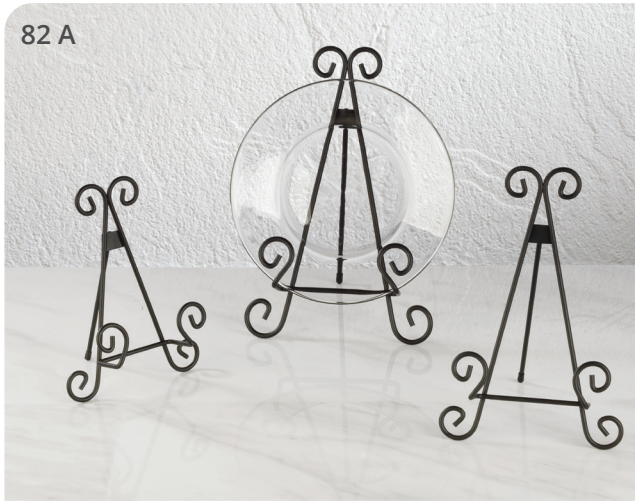

STRATFORD SCROLL STANDS

SMALL EASEL
9"H x 6.55"W x 6.25"D
1.75" D LIP
MIN: 6

MEDIUM EASEL
11"H x 7.15"W x 6.5"D
1.75" D LIP
MIN: 4

LARGE EASEL
13"H x 8"W x 6.75"D
1.75" D LIP
MIN: 4

Code: E00425

Code: E00495

Code: E00550

82 A BLACK FINISH

55809



55811



55813



82 B WHITE FINISH

55909



55911



55913



82 C GOLD FINISH

55709



55711



55713



82 D SILVER FINISH

55509



55511



55513





EASELS MAKE A GREAT ADD-ON SALE

PRICE THEM. TAG THEM. SELL THEM.

83 A

BLACK WIRE ECONOMY FOLDING EASELS

X-Small Black Wire Folding Easel; 5.25”h x 3.75”w x 3.75”d; For 6” plates

Min: 12 Code: E00140  59101

Small Black Wire Folding Easel; 7”h x 5.5”w x 5.25”d; For 8”-10” plates

Min: 12 Code: E00190  59102

Medium Black Wire Folding Easel; 9.5”h x 6.5”w x 6.5”d; For 12” plates

Min: 12 Code: E00225  59104

Large Black Wire Folding Easel; 11”h x 7”w x 7”d; For 14” plates

Min: 12 Code: E00250  59105

X-Large Black Wire Folding Easel; 13”h x 12”w x 8”d; For 16” platters

Min: 12 Code: E00350  59106

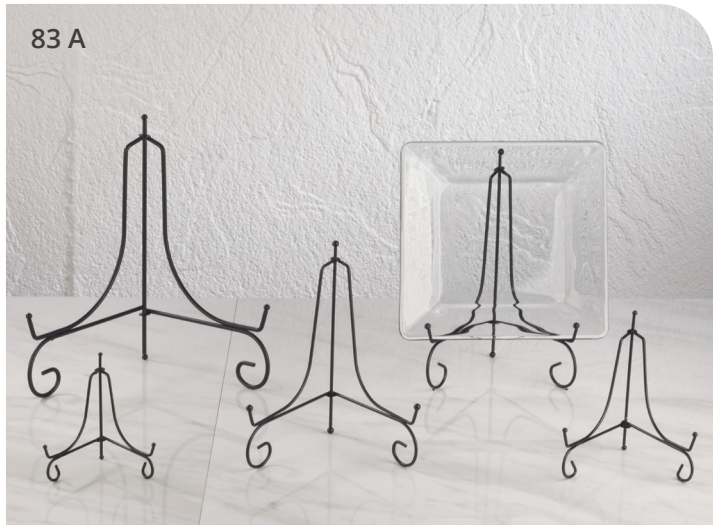

83 B

BLACK ECONOMY SCROLL EASELS

Small Black Scroll Easel; 6.75” h x 5.25” w x 4” d; 1.125” Lip

Min: 6 Code: E00225  59121

Large Black Scroll Easel ; 11.25”h x 8.5”w x 7”d; 1.5” Lip

Min: 6 Code: E00375  59123

83 B

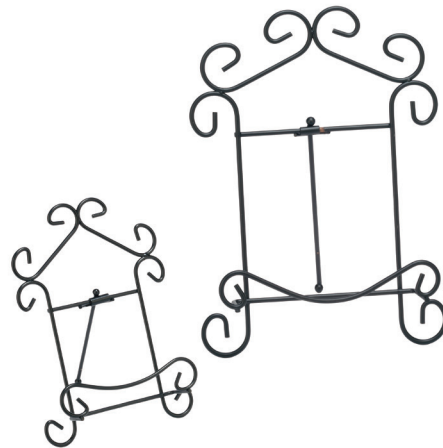

STORE TO HOME

Display

EASELS YOUR CUSTOMERS WILL LOVE

83 C

BLACK STRAIGHT BRACKET EASELS

Small Straight Bracket Easel; 8.75”h x 5.25”w x 6.5”d, 1.75” lip

Min: 6 Code: E00335  54546

Medium Straight Bracket Easel ; 11”h x 6”w x 7.25”d, 1.75” lip

Min: 4 Code: E00400  54547

Large Straight Bracket Easel ; 13”h x 7”w x 8.75”d, 1.75” lip

Min: 4 Code: E00500  54548





Wooden | EASELS

UPDATED COLORS AND BEAUTIFUL FINISHES



ECONOMY STANDS

	4" HIGH FITS ITEMS 3.5" - 5.5" MIN 12 Code: E00170	6" HIGH FITS ITEMS 5" - 7.5" MIN 12 Code: E00255	8" HIGH FITS ITEMS 7" - 9.5" MIN 6 Code: E00330	10" HIGH FITS ITEMS 9" - 11.5" MIN 6 Code: E00430	12" HIGH FITS ITEMS 11" - 14" MIN 6 Code: E00490
84 A WALNUT FINISH	41195 	41196 	41197 	41198 	41199 B
84 B EBONY FINISH	41190 	41191 	41192 	41193 	41194 B

PREMIUM WOOD STANDS



WOODEN EASELS



	5" HIGH WOODEN EASEL FITS ITEMS 4" - 6.5" MIN 6	7" HIGH WOODEN EASEL FITS ITEMS 6.5" - 9" MIN 6	9" HIGH WOODEN EASEL FITS ITEMS 8" - 10.5" MIN 6	11" HIGH WOODEN EASEL FITS ITEMS 10" - 13" MIN 6	12" HIGH WOODEN EASEL FITS ITEMS 11" - 14" MIN 6
85 C WALNUT FINISH R RETAIL PACKAGE	Code: E00290 23-1207 	Code: E00410 23-1204 	Code: E00525 23-1210 	N/A	N/A
85 D EBONY FINISH R RETAIL PACKAGE	23-1205 	23-1202 	23-1208 	N/A	N/A
85 C WALNUT FINISH B BULK	Code: E00250 23-1207B 	Code: E00350 23-1204B 	Code: E00475 23-1210B 	Code: E00575 N/A	Code: E00625 23-1212B
85 D EBONY FINISH B BULK	23-1205B 	23-1202B 	23-1208B 	21014B 	N/A
85 E GOLD FINISH B BULK	23-1249B 	23-1247B 	23-1250B 	N/A	N/A
85 F WHITE FINISH B BULK	41135B 	41137B 	41139B 	N/A	N/A



B Basic Packaging has a UPC tag only. It is **not** designed for hanging display.



R Retail Packaging has a two-color decorative card with product description and usage information. It is designed for hanging display.



Adjustable Display | EASELS

UPDATED COLORS AND BEAUTIFUL FINISHES

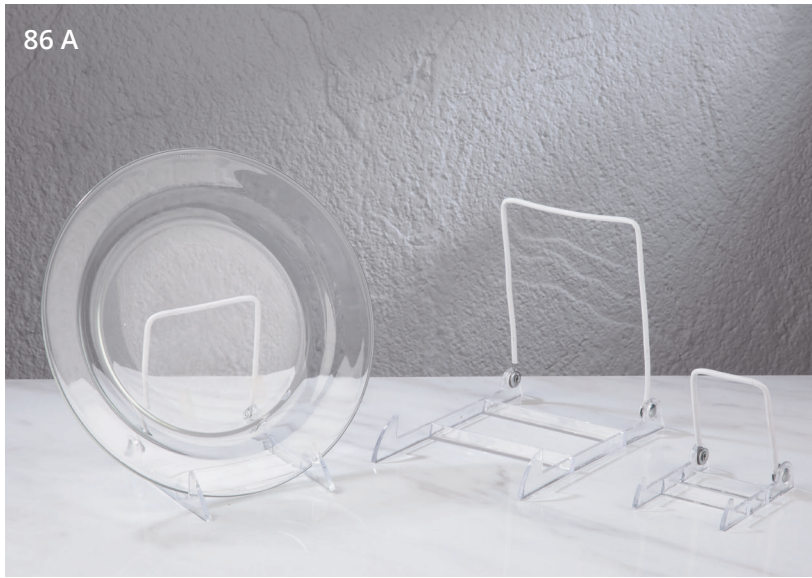

86 A

86 A ADJUSTABLE DISPLAY EASEL

Small

3.5" h x 2.25" w x 3.5" d; Fits items 3" - 8" up to 3" d

Min: 12

Clear Acrylic



Code: E00190

28-1633 R

Black Acrylic



51633 R

Medium

4.5" h x 3.25" w x 5" d; Fits items 8" - 11" up to 4.5" d

Min: 12

Clear Acrylic



Code: E00250

27-1213 R

Black Acrylic



51213 R

Large

6.75" h x 5" w x 7.5" d; Fits items 9" - 18" up to 6" d

Min: 12

Clear Acrylic



Code: E00325

28-1636 R

Black Acrylic



51636 R



86 A

**STRONG
&**

Stylish

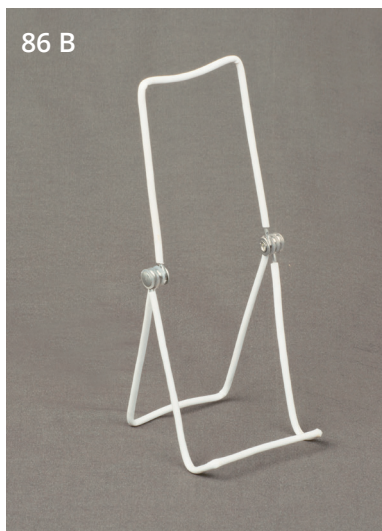

86 B

86 C



86 B WHITE VINYL COATED 3 - WIRE STAND

Displays hard-to-brace platters, large bowls, plates, etc.

Tall single tier adjustable wire stand. 9" h x 3.5" w x 4" d

Min: 12



Code: E00250

27-1227 B

86 C PROTECTIVE CLEAR PADS

Each card has 15 clear self-sticking pads - 3/8" dia.

Protect counter-tops, cabinets and much more from scratching surfaces.

Min: 12



Code: E00240

23-4020 R



Twisted Wire

IN PAINTED
& PLATED FINISHES



Square Wire

IN PAINTED
& PLATED FINISHES

Round Wire

IN PLATED
& VINYL FINISHES



Traditional | WIRE STANDS

PAINTED, PLATED & VINYL FINISHES



88 A



88 B



88 C

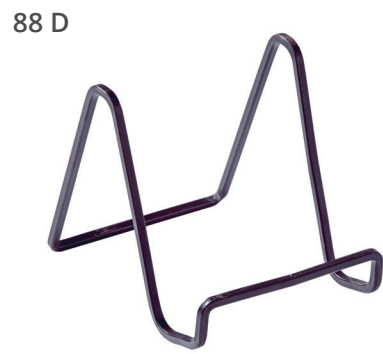

88 D



88 E



88 F

SQUARE WIRE STANDS

3" HIGH
FITS ITEMS 4"- 7"
LIP 3/4"
MIN 12
Code: E00175

4" HIGH
FITS ITEMS 7"- 14"
LIP 1.25"
MIN 12
Code: E00195

6" HIGH
FITS LG. PLATTER 14"+
LIP 1.75"
MIN 6
Code: E00265

88 A SILVER PAINTED

50213



50214



50216



88 B GOLD PAINTED

50223



50224



50226



88 C ANTIQUE WHITE PAINTED

50233



50234



50236



88 D MAHOGANY PAINTED

50203



50204



50206



88 E SILVER PLATED

Code: E00250
19803



Code: E00300
19804



Code: E00375
19806



88 F BRASS PLATED

19813



19814



19816



All items on page 88 & 89 have versatile Retail Packaging which has a two-color decorative card with product description and usage information. These items can be hung or tabletop displayed.

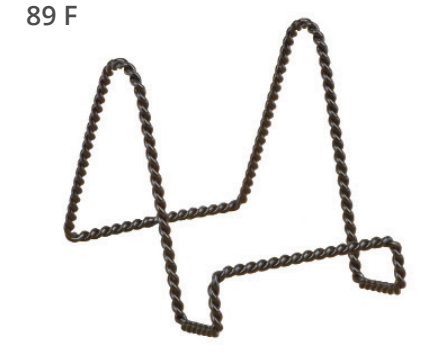

SMOOTH ROUND WIRE STANDS

	2" HIGH FITS ITEMS 2"- 5" LIP 5/8" MIN 12	3" HIGH FITS ITEMS 4"- 7" LIP 3/4" MIN 12	4" HIGH FITS ITEMS 7"- 14" LIP 1-3/8" MIN 12	6" HIGH FITS LG PLATTER LIP 1 - 3/4" MIN 6
89 A BRASS PLATED	N/A	Code: E00135 23-1263 	Code: E00160 23-1264 	Code: E00245 23-1266
89 B WHITE VINYL	N/A	Code: E00120 30-1293 	Code: E00145 30-1294 	Code: E00225 30-1296
89 C CHROME PLATED	N/A	Code: E00135 23-1223 	Code: E00160 23-1224 	Code: E00245 23-1226

DOUBLE TWISTED WIRE STANDS

89 D CHROME PLATED	N/A	Code: E00095 23-1233 	Code: E00165 23-1234 	Code: E00260 23-1236
89 E BRASS PLATED	23-1239 	23-1243 	23-1244 	23-1246
89 F BLACK PAINTED	N/A	23-1240 	23-1241 	23-1242



Wall | ART

FUNCTIONAL & FASHIONABLE DECOR



90 A



90 B



90 C



90 D



90 E



90 F

90 A
GOLD WAVE STARBURST MIRROR

Overall size is 36" diam. x 2" deep;
Mirror is 12.75" diam.
Weights 7 lbs.

Oversized; Additional Freight

Min: 1 Code: E16500



20519

90 B 
MODERN STARBURST MIRROR

Overall size is 36" diam. x 3" deep; Mirror
is 10" diameter.
Weight is 5 pounds.

Oversized High UPS Surcharge - Truck Only

Min: 1 Code: E15000



20518

90 C
FEATHER MIRROR - METAL

Overall size is 37" diam. x 1.75" deep;
Mirror 13" diam.
Weight is 7 lbs.

Oversized; Additional Freight

Min: 1 Code: E16500



20517

90 D
METAL FLOWER WALL DECOR - SET/3

Features a silver antique finish on gold.

Small: 7"h x 7"w x .5"d

Medium: 12"h x 12"w x .75"d

Large: 24.75"h x 24.75"w x 1.25"d

Min: 1 set Code: S04500



20592

90 E
**GOLD FOIL SUNBURST
WALL MIRROR**

Overall size is 31" diam. x 1" deep;
Mirror is 11.75" diameter.
Weight is 6.75 lbs.

Oversized; Additional Freight

Min: 1 Code: E12500



19785

90 F
**RITZ MANDALA WALL MIRROR
W/ TEARDROP ACCENTS**

Overall size is 35.25" diam. x 1.25" deep;
Mirror is 14.75" diameter.
Weight is 6.75 lbs.

Oversized; Additional Freight

Min: 1 Code: E12500



18547



91 A
METAL BRANCH WALL DECOR

Beautiful decor which can also be used for displaying/hanging jewelry.
38.6" h x 26" w x 3.95" d

Gold
Min: 1 Code: E11000
 **20515**

96 B
26" ROUND WALL MIRROR

Overall size is 26" dia. x 1.75" d
Mirror is 24.75" dia.

Min: 1 Code: E07000
 **21575**

91 C
WALL DECOR MIRROR

Wall mirror featuring a hammered painted finish with gold accents;
Oversized; Additional Freight
Overall size is 31.5" dia x 2" d;
Mirror: 14.5" dia

Black/gold
Min: 1 Code: E07500
 **21525**

White/gold
Min: 1 Code: E07500
 **20562**

LIGHT
&
Bright



SMALL STARBURST
WALL ART
7"DIA x 1.5"D
MIN 2

Code: E00800
17616

MEDIUM STARBURST
WALL ART
13"DIA x 1.75"D
MIN 1

Code: E01600
17617

LARGE STARBURST
WALL ART
28"DIA x 2"D
MIN 1

Code: E06500
17618



91 D GOLD ACRYLIC



91 E SILVER ACRYLIC



33617



33618







RUSTIC Elegance



92 A

92 A
31" ROUND WOOD WALL MIRROR

Overall size is 31" diam. x 2.75" deep;
Mirror is 22" diam.

Oversized; Additional Freight

Min: 1

Code: E14000



21577

92 B
ACOUSTIC GUITAR WALL ART

Wood and Metal
36.25"h x 13.25"w x 1"d

Min: 1

Code: E04900



18546



92 C

92 C 
**DIMENSIONAL WOODEN
WALL MIRROR**

Starburst Style Multi Dimensional Wall Art
Overall size is 39.5" dia. x 2.75" d;
Mirror is 11" dia.

*High UPS Surcharge - Truck only; Oversized;
Additional Freight*

Min: 1 Code: E13500  17901



92 D

92 D
**DOUBLE EDGED ROUND
METAL MIRROR**

Simple, contemporary design
Overall size is 31" diam. x 2.15" deep;
Mirror is 30.5" diam.

Oversized; Additional Freight

Min: 1 Code: E10500  20563



92 B



93 A
WOOD CLOTHES PIN SHELF
BLACK - SMALL
(Available Mid-year)

5.15"h x 23.7"w x 4.9"d

Min: 2 **Code: E04700**
22602



93 B
CLOTHESPIN SHELF - BROWN SET/2

Large: 6"h x 30"w x 6"d

Small: 5"h x 23.5"w x 4.87"d

Min: 1 set **Code: S11500**
19675



93 C
ONE LARGE BROWN CLOTHESPIN SHELF
6"h x 30"w x 6"d

Min: 1 **Code: E06800**
21552



93 D
SPOON & FORK WALL ART 2-PC

Antiqued silver utensil on cloth board and

natural wood frame

Each Board: 31.5"h x 10"w x 1.5"d

Min: 1 set **Code: S06800**
18748



93 E
CORKSCREW & WIRE BASKET
WALL ART - SET/2

Use to collect corks, mail, cards, photos and more. 17.25"h x 11"w x 3.5"d

Min: 1 set **Code: S05700**
18749



93 F
9" SQUARE ANTIQUED MIRROR

Edges are antiqued to create a worn appearance. 9" sq. x 1.65"d

Min: 4 **Code: E03000**
19747



93 G
18" SQUARE ANTIQUED MIRROR

18" square x 1.5"d

Min: 2 **Code: E04200**
19748



93 H
RUSTIC WOOD SHELF
WITH DEEP METAL LIP - SET/2

Great for pictures, frames and signs

Large: 26"w x 7"h x 4.5"d; 3-1/8"d lip

Small: 21.5"w x 7"h x 4.5"d; 3-1/8"d lip

Min: 1 set **Code: S05000**
18751



93 A



93 B (Set)



93 C (Large)

93 D



93 E



93 F

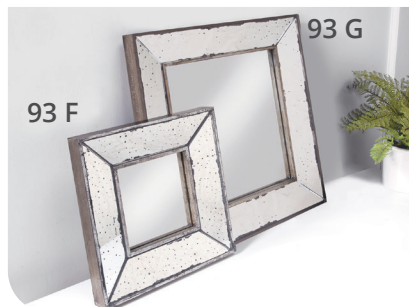

93 G

93 H





Decorative | WALL ART

RUSTIC, WOOD & METAL

94 A



94 B



94 C



94 D



94 A
RUSTIC WALL CLOCK

2-Finish Wood Clock
23.5" h x 23.5" w x 1.75" d

1 AA Battery Required

Min: 1 **Code: E05500**



19603

94 B
LIVE LAUGH LOVE WALL ART

Antique Brown Finish Live Love Laugh
21" h x 20.75" w x 12.5" d

Min: 1 **Code: E02000**



58805

94 C
LIVE LAUGH LOVE WALL ART

White Finish Live Love Laugh
21" h x 20.75" w x 12.5" d

Min: 1 **Code: E02000**



58806

94 D
METAL/ WOOD BICYCLE WALL ART

Handle, Seat & Pedal are Wood
28" h x 46.5" w x 4" d

Min: 1 **Code: E09900**



16465



95 A

Great for storing ribbon spools & toilet paper

**95 A
LITTLE BIRD METAL HOLDER**

25.5"h x 6.15"w x 6.15"d

Min: 2 Code: E02200



19649



**95 B
ANTIQUE STYLE WALL
HANGING DOOR HANDLE**

Great hooks for hanging clothes, jewelry and more.

5.75"h x 2"w x 1.375"d

Cream Hanging Door Handle

Min: 2 Code: E00775



16432

Brown Hanging Door Handle

Min: 2 Code: E00775



16433

95 B



95 C

**95 C
SINGLE WATER SPIGOT
WALL HANGER**

3.25"dia x 2.5"d

Min: 3 Code: E00425



16497



**95 D
3 KNOB WATER SPIGOT
WALL HANGER**

5.75"h x 17"w x 6"d

Min: 1 Code: E01450



16496



\$100
minimum order



TRIPAR
INTERNATIONAL, INC.

SOLUTIONS
To Inspire

We would love to connect;
Send us your visual
stories and inspirations!

Tag **@triparinternational**
on socials to get featured.



And follow
<https://blog.tripar.com>
for news and trends

Phone
800-222-1142

Local Phone
630-980-5100

Fax
800-648-9015

Email
orders@tripar.com

Website
www.tripar.com

20 Presidential Drive,
Roselle, Illinois 60172 USA



Phone
800-222-1142

Local Phone
630-980-5100

Fax
800-648-9015

Email
orders@tripar.com

Website
www.tripar.com

20 Presidential Drive,
Roselle, Illinois 60172 USA



©2022 Tripar International, Inc.
All Rights Reserved.